

FIO Series

► Fiber optics and optical frontends

Fiber optics (optical fibers) offer solutions for difficult tasks in optoelectronics and are primarily used wherever compact devices are too big, too heavy, or technically unviable.

- Universally applicable
- Superior quality
- Various fiber types available
- Great variety of available standard sensor heads
- Various optical frontends and accessories available
- Optionally with thermal stability or vibration protection
- Special designs



Characteristics

Light-conducting glass fibers are optical components that allow the transmission of light through any curved path based on the principle of total reflection. The individual fiber is composed of high-break core glass and low-break cladding glass. The light beams entering the core glass within the critical angle are guided through the fiber by way of reflection at the core/cladding contact surfaces (step index fiber).

The highly flexible fiber optics are made of bundled individual glass fibers. The ends are each glued into a sensor head and a connector. The faces are optically polished. For protection against mechanical, chemical, or thermal destruction the optical fibers are provided with a corresponding protective sheath.



Application Examples

The examples shown here represent but a small selection from the variety of possibilities for using fiber optics with our optical sensors.

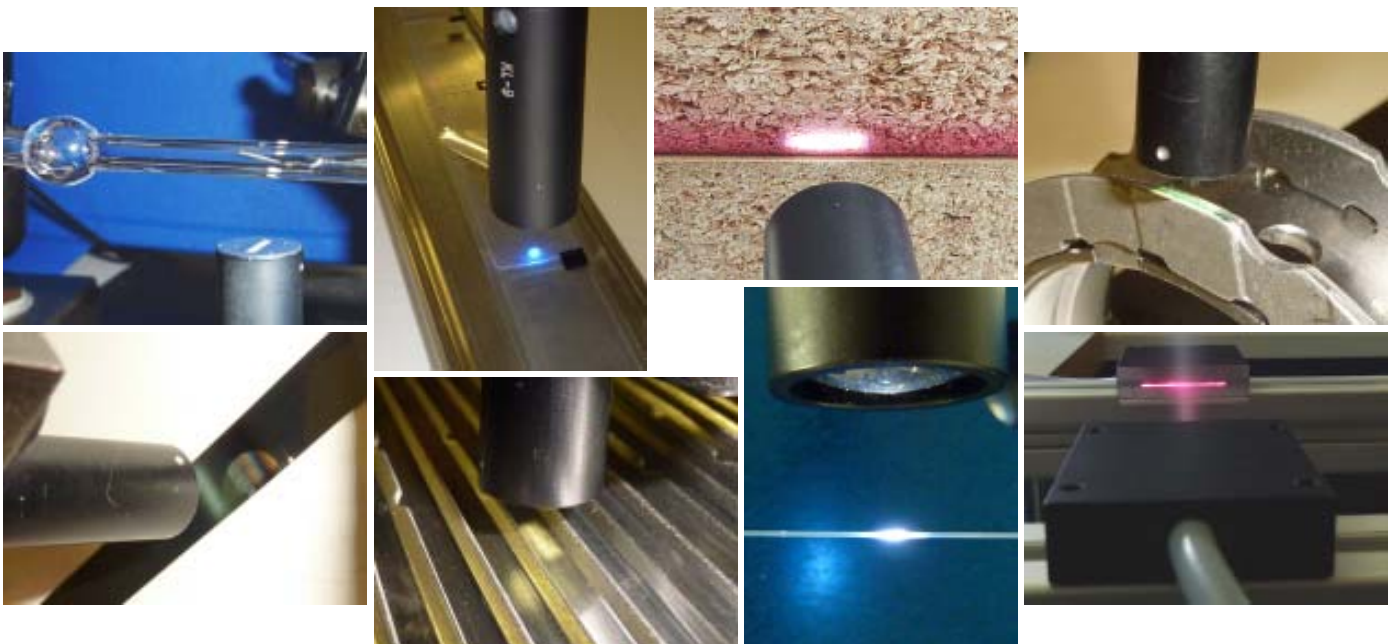



General informationen on fiber optics

| | |
|--|------|
| Technical data | p. 3 |
| Order code | p. 3 |
| Function | p. 4 |
| Sheath | p. 4 |
| Sensor head types A, B, C, M, Q, R | p. 5 |
| Sensor head types D, E, F, O | p. 6 |
| Standard lengths | p. 7 |
| Opening angle | p. 7 |
| Dimensions of adaptor | p. 7 |
| Mounting hints | p. 7 |

Fiber optics

| | |
|---|-------|
| Reflected light fiber optics | p. 8 |
| Reflected light fiber optics Y-shape (67°/67°) | p. 15 |
| Transmitted light fiber optics | p. 16 |
| UV fiber optics (22°-UV) | p. 19 |
| UV fiber optics Y-shape (22°/67°-UV) | p. 20 |
| UV fiber optics Y-shape (22°/67°/67°-UV) | p. 21 |
| Special fiber optics X-shape (two measuring heads, fibers arranged crosswise) | p. 22 |

Optical frontends

| | |
|--|-------|
| Overview: Optical frontends for fiber optics | p. 23 |
| Optical frontends for reflected light or transmitted light fiber optics (characteristics) | p. 24 |
| Optical frontends for reflected light fiber optics in Y-shape (67°/67°) | p. 26 |
| Optical frontends for UV fiber optics (22°-UV) and UV fiber optics in Y-shape (22°/67°-UV) | p. 27 |
| Optical frontends for UV fiber optics in Y-shape (22°/67°/67°-UV) | p. 29 |

Product descriptions optical frontends

| | |
|--|-------|
| KL-1-A2.0 (Focus lens for transmitted light fiber optics) | p. 30 |
| KL-2-A2.0 (Focus lens for transmitted or reflected light fiber optics) | p. 30 |
| KL-3-A2.0 (Focus lens for reflected light fiber optics) | p. 30 |
| KL-4-A1.1 (Focus lens for reflected light fiber optics) | p. 32 |
| KL-5-R1.1 (Focus lens for reflected light fiber optics) | p. 32 |
| KL-8-R2.1 (Focus lens for reflected light fiber optics) | p. 33 |
| KL-8-N-R2.1 (Focus lens, with guide slot, for reflected light fiber optics) | p. 34 |
| KL-9-A3.0 (Focus lens for reflected light fiber optics) | p. 34 |
| KL-90-A2.0 (Prismatic optics for transmitted light fiber optics) | p. 35 |
| KL-M8-A1.1 (Reflection optics for reflected light fiber optics) | p. |
| KL-M12-... (Reflection optics for reflected light fiber optics) | p. |
| KL-M12-XL-... (Reflection optics for reflected or transmitted light fiber optics) | p. |
| KL-M18-... (Reflection optics for reflected light fiber optics) | p. |
| KL-M18-XL-... (Reflection optics for reflected light fiber optics) | p. |
| KL-M34-... (Reflection optics for reflected light fiber optics) | p. |
| KL-M34-XL-... (Reflection optics for reflected light fiber optics) | p. |
| KL-M34/62-R2.1 (Reflection optics for reflected light fiber optics) | p. |
| KL-D-0°/2.5°-300-A2.0 (Reflection optics for transmitted light fiber optics) | p. |
| KL-D-6°-200-A2.0 (Reflection optics for transmitted light fiber optics) | p. |
| KL-D-14°-86-A2.0 (Reflection optics for transmitted light fiber optics) | p. |
| KL-D-14°-86-A2.0-T400 (Reflection optics for transmitted light fiber optics, high temperature resistant) | p. |
| KL-D-17°-49-A2.0 (Reflection optics for transmitted light fiber optics) | p. |
| KL-D-20°-31-A2.0 (Reflection optics for transmitted light fiber optics) | p. |
| KL-D-28°-26-A2.0 (Reflection optics for transmitted light fiber optics) | p. |
| KL-D-30°-23-A2.0 (Reflection optics for transmitted light fiber optics) | p. |
| KL-D-40°-13-A2.0 (Reflection optics for transmitted light fiber optics) | p. |
| KL-D-3/30-R/D-A2.0 (Optical frontend for special fiber optics - reflected light/transmitted light) | p. |

Accessories

| | |
|---|-------|
| Fiber optics fixtures (mounting brackets) | p. 64 |
| Neutral glass filter top-parts for fiber optics | p. 66 |
| Offline top-parts (spacer) for fiber optics | p. 66 |
| Alignment fixture for optical frontends | p. 66 |



Technical Data

| Fiber optics of FIO Series | |
|---|---|
| Diameter of a single fiber | 70 µm (standard fiber, optimum ratio between transmission and flexibility) |
| Opening angle | standard fiber 67° (NA 0,56) special fiber 22° (NA 0,21) special UV fiber 22° (80/100 µm) |
| Material | optical glass (e.g. quartz glass) |
| Dielectric strength | 50 kV/mm with PVC sheathing |
| Special versions | -VS : version with vibration protection -T400 : version with increased temperature stability up to +400°C (due to special bonding of the fibers) |
| Permissible temperature range for various sheathings with a corresponding fiber bonding | PVC (P): -20°C ... +80°C Metal (M): -40°C ... +300°C Metal with special bonding (E): -40°C ... +400°C Silicone-metal (S): -40°C ... +180°C |



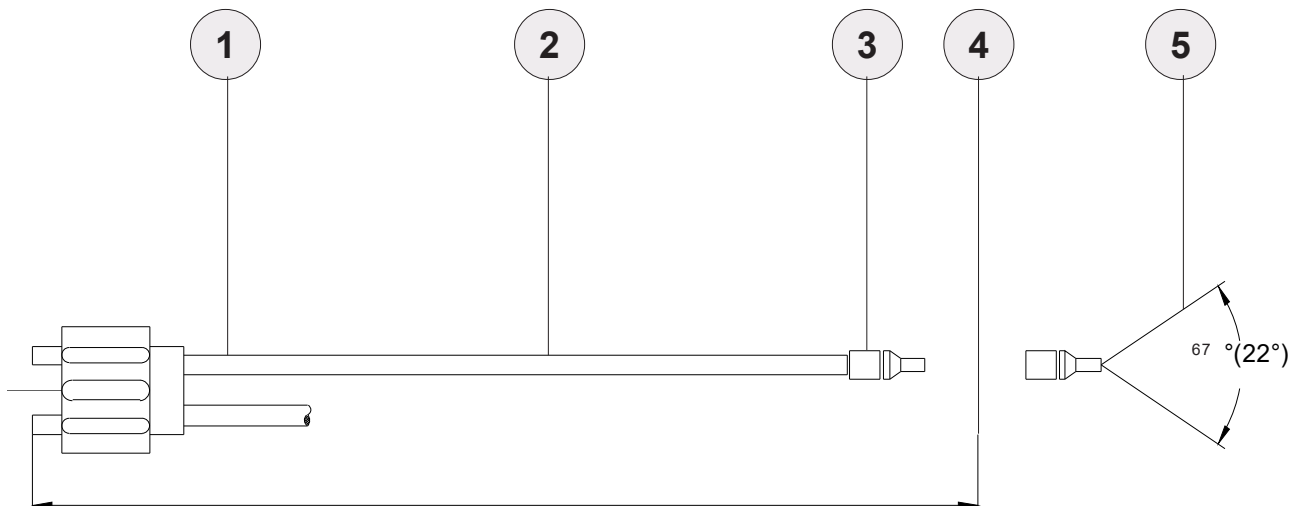
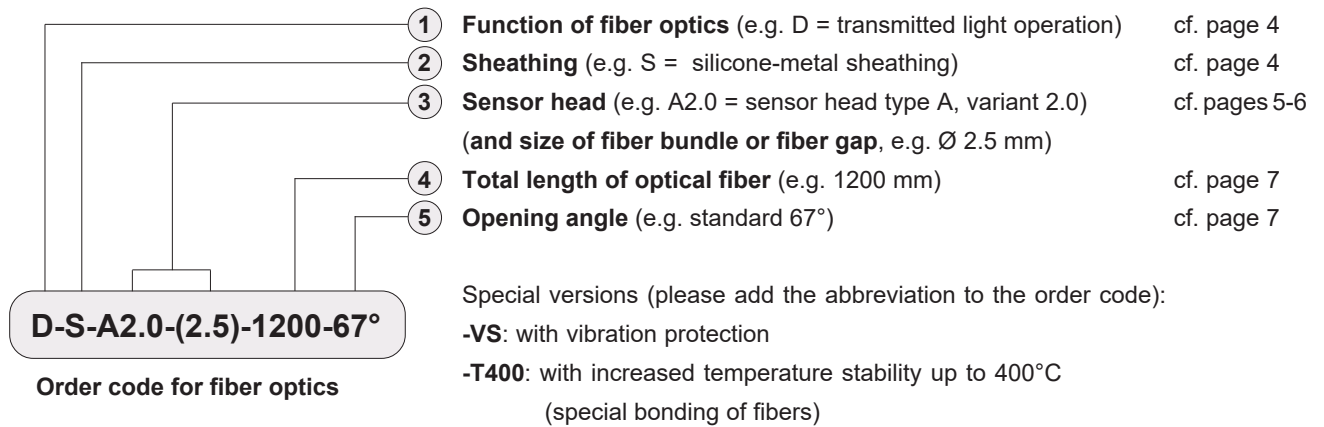

Order Code

You can put together your own individual fiber optics by selecting the different components of the order code:





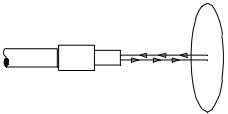

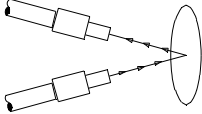

Function

| Reflected light operation (R) | Transmitted light operation (D) | |
|--|---|---|
| <p>Reflection</p>  <p>Transmitter and receiver fibers are contained in one fiber optics cable. The light comes from the transmitter fibers, is reflected at the object to be measured, and reaches the evaluation amplifier through the receiver fibers.</p> | <p>Barrier</p>  <p>Transmitter and receiver fibers are separated and arranged opposite each other. The received quantity of light, which is evaluated by the amplifier, changes in accordance with the degree of covering of the light beam.</p> | <p>V-arrangement</p>  <p>Transmitter and receiver fibers are arranged at a certain angle. The light is reflected at the object to be measured and reaches the evaluation amplifier through the receiver fibers. <u>Advantage:</u> Gloss and reflection on surfaces can be suppressed.</p> |



Sheathing

| | |
|--|---|
| <p>P = PVC special sheath</p> | <p>S = Silicone-metal sheath</p> |
|  |  |
| <p>Plastic hose</p> <p><u>Characteristics:</u></p> <ul style="list-style-type: none"> - For rigid installations - Small sheath diameter - Temperature-stable to 80 °C <p>Bending radius corresponds to twice the external diameter of the sheath.</p> | <p>Metal wire-spiral-reinforced hose with glass-fiber braiding and silicone rubber sheathing</p> <p><u>Characteristics:</u></p> <ul style="list-style-type: none"> - Very flexible, ideal for frequent bending - Highly resistant to bending, tension and torsion - Temperature-stable to 180 °C - Liquid-tight <p>Bending radius corresponds to three times the external diameter of the sheath.</p> |
| <p>M = Metal sheath</p> | <p>E = VA stainless-steel sheath</p> |
|  |  |
| <p>Flexible brass wire-spiral-reinforced hose, chrome-plated</p> <p><u>Characteristics:</u></p> <ul style="list-style-type: none"> - Flexible - Protection against mechanical stress - Temperature-stable to 180 °C <p>Bending radius corresponds to three times the external diameter of the sheath.</p> | <p>Flexible stainless steel wire-spiral-reinforced hose</p> <p><u>Characteristics:</u></p> <ul style="list-style-type: none"> - Flexible - Protection against mechanical stress - Temperature-stable to 400 °C - Stainless <p>Bending radius corresponds to three times the external diameter of the sheath.</p> |





Sensor Heads

Sensor head Type A (end sleeve: special steel)

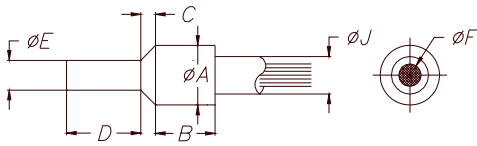

| Type | A | B | C | D | E | F | ØJ | | |
|------|-----|----|---|----|-----|-----|----|---|-----|
| | Ø | | | | Ø | Ø | P | M | S |
| A1.0 | 4.6 | 8 | 2 | 11 | 2.5 | 1.5 | 4 | - | - |
| A1.1 | 6.6 | 8 | 2 | 11 | 2.5 | 1.5 | - | 5 | 4.4 |
| A2.0 | 6.6 | 10 | 2 | 12 | 4.5 | 2.5 | 6 | 6 | 5.8 |
| A3.0 | 8.5 | 11 | 2 | 15 | 6.0 | 3.0 | 7 | 7 | 7.5 |

A1.0 end sleeve suitable for PVC sheath only (P)

Sensor head Type D (end sleeve: special steel)

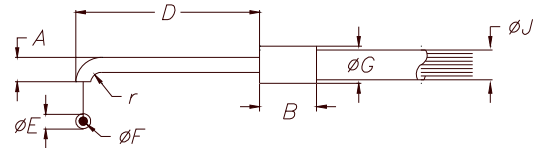

| Type | A | B | D | E | F | G | r | ØJ | | |
|------|-----|----|----|---|-----|---|-----|----|---|-----|
| | Ø | | | Ø | Ø | Ø | | P | M | S |
| D1.0 | 2.5 | 10 | 20 | 1 | 0.6 | 3 | 1.5 | 2 | - | - |
| D1.1 | 2.5 | 13 | 20 | 1 | 0.6 | 6 | 1.5 | - | - | 4.4 |
| D2.0 | 6 | 13 | 20 | 2 | 1.5 | 6 | 4 | 5 | 5 | 4.4 |
| D3.0 | 15 | 17 | 20 | 5 | 2.5 | 9 | 10 | 7 | 7 | 6.5 |

D1.0 end sleeve suitable for PVC sheath only (P)

Sensor head Type B (suitable for PVC sheath only)

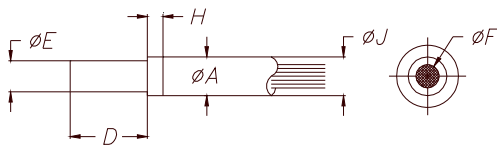

| Type | A | D | E | F | H | ØJ | End sleeve |
|------|---|----|---|-----|---|----|---------------|
| | Ø | | Ø | Ø | | P | |
| B1.1 | 2 | 30 | 1 | 0.6 | 2 | 2 | Special steel |
| B1.2 | 2 | 10 | 1 | 0.6 | 2 | 2 | Special steel |
| B2.0 | 3 | 10 | 2 | 1.0 | 2 | 3 | Aluminum |
| B3.0 | 5 | 12 | 4 | 2.5 | 2 | 5 | Aluminum |
| B4.0 | 8 | 12 | 6 | 3.0 | 2 | 8 | Aluminum |

Sensor head Type E (end sleeve: special steel)

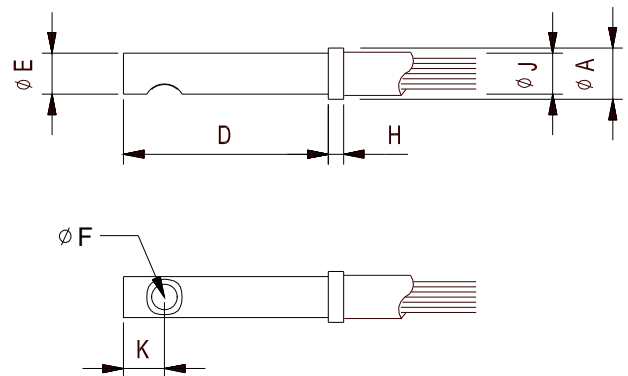

| Type | A | D | E | F | H | K | ØJ | | |
|------|---|----|---|-----|-----|---|----|---|-----|
| | Ø | | Ø | Ø | | | P | M | S |
| E1.0 | 4 | 20 | 3 | 1.5 | 1.5 | 4 | 4 | - | - |
| E2.0 | 5 | 20 | 4 | 2.5 | 1.5 | 4 | 5 | 5 | - |
| E2.1 | 7 | 20 | 4 | 2.5 | 10 | 4 | - | - | 5.8 |
| E3.0 | 8 | 20 | 6 | 3.0 | 1.5 | 5 | 7 | 7 | - |

E1.0 end sleeve suitable for PVC sheath only (P)

Sensor head Type C (end sleeve: special steel)

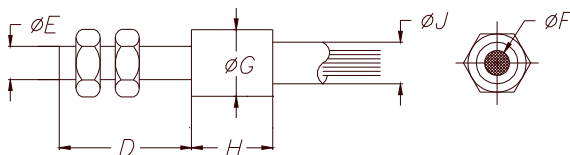

| Type | D | E | F | G | H | ØJ | | |
|------|----|-----|-----|----|----|----|---|-----|
| | | | Ø | Ø | | P | M | S |
| C1.0 | 30 | M4 | 1.0 | 6 | 13 | 5 | 5 | 4.4 |
| C2.0 | 30 | M6 | 2.5 | 8 | 15 | 6 | 6 | 5.8 |
| C3.0 | 30 | M10 | 3.0 | 11 | 12 | 7 | 7 | 7.5 |





Sensor Heads

Sensor head Type F (end sleeve: special steel)

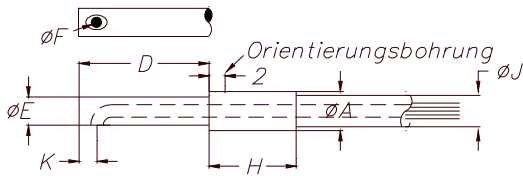

| Type | A | D | E | F | H | K | ØJ | | |
|------|----|----|----|-----|----|---|----|---|-----|
| | Ø | | Ø | Ø | | | P | M | S |
| F1.0 | 8 | 20 | 6 | 1,5 | 9 | 3 | 5 | 5 | 5,8 |
| F2.0 | 10 | 20 | 8 | 2,5 | 10 | 4 | 6 | 6 | 6,5 |
| F3.0 | 12 | 20 | 10 | 3 | 10 | 5 | 7 | 7 | 7,5 |

Sensor head Type O (flexible)

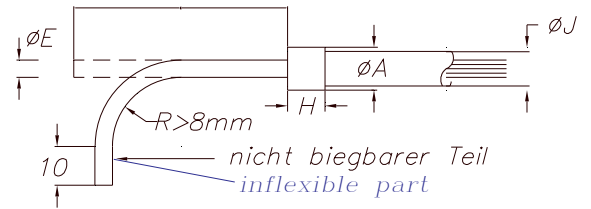

| Type | A | D | E | F | H | ØJ | | |
|------|---|-----|-----|-----|----|----|---|-----|
| | Ø | | Ø | Ø | | P | M | T |
| O1.0 | 2 | 100 | 1 | 0,6 | 10 | 2 | - | - |
| O1.1 | 7 | 100 | 1 | 0,6 | 20 | - | 5 | 4,4 |
| O2.0 | 3 | 100 | 1,3 | 1 | 10 | 3 | - | - |
| O2.1 | 7 | 100 | 1,3 | 1 | 20 | - | 5 | 4,4 |

This flexible endsleeve can be formed into the desired shape.

Sensor head Type M (end sleeve: special steel or alu)

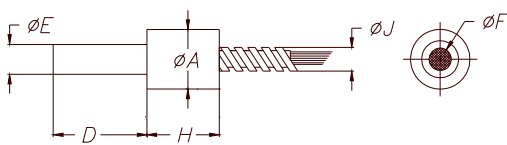

| Type | A | D | E | F | H | ØJ | | Endhülse |
|-------|----|----|----|------|----|----|------|---------------|
| | Ø | | Ø | Ø | | M | S | |
| M1.1 | 6 | 30 | 1 | 0,6 | 10 | 5 | 4,4 | Special steel |
| M1.2 | 6 | 10 | 1 | 0,6 | 10 | 5 | 4,4 | Special steel |
| M2.0 | 6 | 10 | 2 | 1,0 | 10 | 5 | 4,4 | Aluminum |
| M3.0 | 7 | 12 | 4 | 2,5 | 12 | 6 | 5,8 | Aluminum |
| M4.0 | 9 | 12 | 6 | 3,5 | 12 | 7 | 7,5 | Aluminum |
| M5.0 | 12 | 16 | 7 | 5,0 | 16 | 9 | 9,0 | Aluminum |
| M6.0 | 13 | 16 | 8 | 6,0 | 18 | 10 | 11,5 | Aluminum |
| M8.0 | 16 | 20 | 10 | 8,0 | 20 | 13 | 13,5 | Aluminum |
| M10.0 | 18 | 20 | 12 | 10,0 | 20 | 15 | - | Aluminum |

Sensor head Type Q (end sleeve: aluminium)

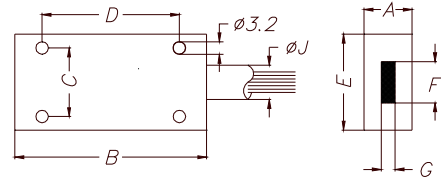

| Type | A | B | C | D | E | F | G | ØJ |
|------|----|----|----|----|----|----|------|----|
| | Q1 | 12 | 25 | 9 | 15 | 15 | 5 | |
| Q2 | 12 | 30 | 14 | 20 | 20 | 10 | 0,3 | |
| Q3 | 12 | 35 | 24 | 25 | 30 | 18 | 0,3 | |
| Q4 | 12 | 55 | 34 | 40 | 40 | 28 | 0,2 | |
| Q5 | 12 | 55 | 44 | 40 | 50 | 38 | 0,15 | |
| Q6 | 12 | 55 | 54 | 40 | 60 | 48 | 0,15 | |

Sensor head Type R (end sleeve: aluminium)

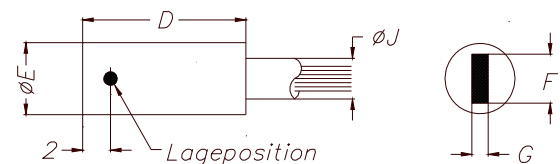

| Type | D | E | F | G | ØJ | | |
|------|----|----|---|------|----|---|-----|
| | | Ø | | max. | P | M | S |
| R1.0 | 25 | 4 | 3 | 0,5 | 3 | - | - |
| R1.1 | 30 | 7 | 3 | 0,5 | 6 | 6 | 5,8 |
| R2.0 | 25 | 7 | 6 | 1,0 | 6 | - | - |
| R2.1 | 30 | 10 | 6 | 1,0 | - | 7 | 7,5 |

R1.0 +R2.0 end sleeves suitable for PVC sheath only (P)



Standard Lengths

Available standard lengths are 600 mm or 1200 mm ((special cable lengths are also available), length tolerance +2%



Total length l = 600 mm or 1200 mm



Total length l = 600 mm or 1200 mm

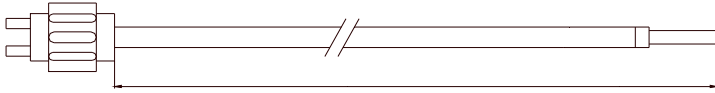

Total length l = 600 mm or 1200 mm

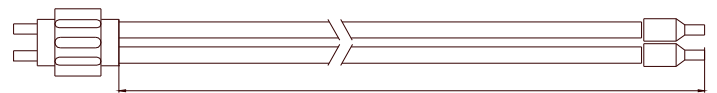

Total length l = 600 mm or 1200 mm

Opening Angle

Depending on the glass-fiber material used, the following beam angles are available in the standard product range:

Schematic drawing:
Opening angle 67°

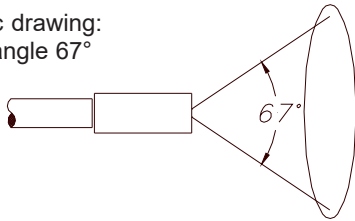

Schematic drawing:
Opening angle 22°

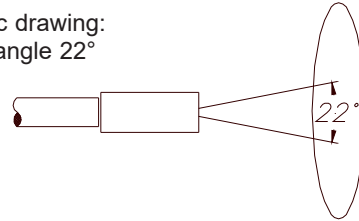

Dimensions of Adaptor

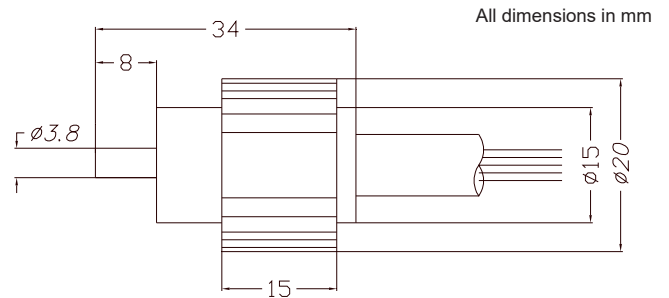
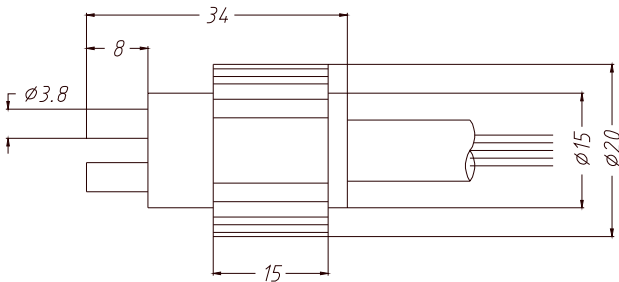

Mounting hints

Please note the following information on the usage and mounting of optical fibers:

Fiber optics consist of a large number of single glass fibers with a diameter from 10 up to 70 µm. In spite of their high flexibility and resistance they have to be protected against tension, twist off, and bend.



Bending radius: Sheathing type „S“: Bending radius corresponds to three times the external diameter of the sheath.
 Sheathing type „E“ and „M“: Bending radius corresponds to three times the external diameter of the sheath.
 Sheathing type „P“: Bending radius corresponds to twice the external diameter of the sheath.

Mounting: Without heavy pressure to the fiber
 Installation: Tension-free!

For applications with heavy mechanical strain we recommend to use fiber optics with silicone-metal sheath.

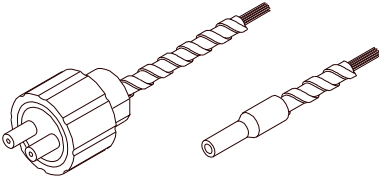
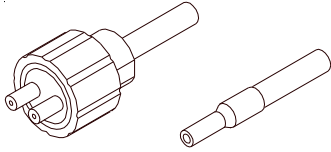
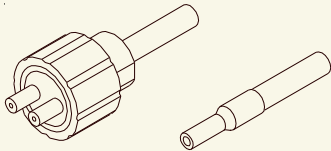

Reflected Light

| Fiber optics | Shape (adaptor and sensor head) | Product description |
|---|--|--|
| <p>R-M-A1.1-(1.5)-600-67° R-M-A1.1-(1.5)-1200-67°</p> | <p>Sheathing type „M“: cf. page 4 Sensor head „A1.1“: cf. page 5 Adaptor: cf. page 7</p> | <p>Reflected light operation (R) Metal sheath (M) Sensor head A1.1 (fiber bundle Ø 1.5 mm) Total length 600 mm or 1200 mm Beam angle 67°</p> |
| <p>R-S-A1.1-(0.6)-600-67° (-22°) R-S-A1.1-(1.0)-600-67 (-22°) R-S-A1.1-(1.1)-600-67° (-22°) R-S-A1.1-(1.5)-600-67° (-22°)</p> | <p>Sheathing type „S“: cf. page 4 Sensor head „A1.1“: cf. page 5 Adaptor: cf. page 7</p> | <p>Reflected light operation (R) Silicone-metal sheath (S) Sensor head A1.1 (fiber bundle optionally Ø 0.6 mm, Ø 1.0 mm, Ø 1.1 mm or Ø 1.5 mm) Total length 600 mm or 1200 mm Beam angle 67° or 22°</p> |
| <p>R-E-A2.0-(2.5)-600-67° R-E-A2.0-(2.5)-1200-67° R-E-A2.0-(2.5)-1200-67°-T400 R-E-A2.0-(2.5)-4000-67°-T400</p> |  | <p>Reflected light operation (R) Stainless steel sheath VA (E) Sensor head A2.0 (fiber bundle Ø 2.5 mm) Total length 600 mm, 1200 mm, or 4000 mm Beam angle 67° Special version: High temperature stable (T400)</p> |
| <p>R-M-A2.0-(2.5)-600-67° R-M-A2.0-(2.5)-1200-67°</p> | <p>Sheathing type „M“: cf. page 4 Sensor head „A2.0“: cf. page 5 Adaptor: cf. page 7</p> | <p>Reflected light operation (R) Metal sheath (M) Sensor head A2.0 (fiber bundle Ø 2.5 mm) Total length 600 mm or 1200 mm Beam angle 67°</p> |
| <p>R-P-A2.0-(2.5)-600-67° R-P-A2.0-(2.5)-600-22° R-P-A2.0-(2.5)-1200-67° R-P-A2.0-(2.5)-1200-22°</p> |  | <p>Reflected light operation (R) PVC special sheath (P) Sensor head A2.0 (fiber bundle Ø 2.5 mm) Total length 600 mm or 1200 mm Beam angle 67° or 22°</p> |
| <p>R-S-A2.0-(2.5)-600-67° R-S-A2.0-(2.5)-600-22° R-S-A2.0-(2.5)-1200-67° R-S-A2.0-(2.5)-1200-22°</p> |  | <p>Reflected light operation (R) Silicone-metal sheath (S) Sensor head A2.0 (fiber bundle Ø 2.5 mm) Total length 600 mm or 1200 mm Beam angle 67° or 22°</p> |
| <p>R-P-A3.0-(3.0)-600-67° R-P-A3.0-(3.0)-600-22° R-P-A3.0-(3.0)-1200-67° R-P-A3.0-(3.0)-1200-22°</p> | <p>Sheathing type „P“: cf. page 4 Sensor head „A3.0“: cf. page 5 Adaptor: cf. page 7</p> | <p>Reflected light operation (R) PVC special sheath (P) Sensor head A3.0 (fiber bundle Ø 3.0 mm) Total length 600 mm or 1200 mm Beam angle 67° or 22°</p> |

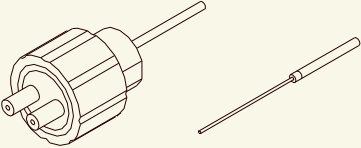
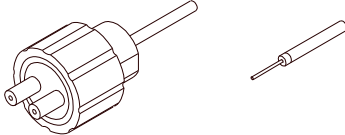
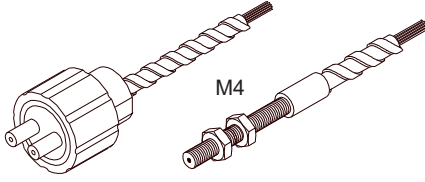
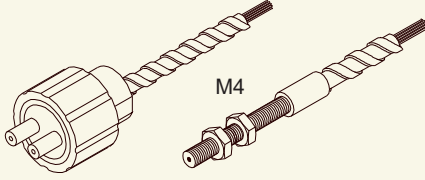
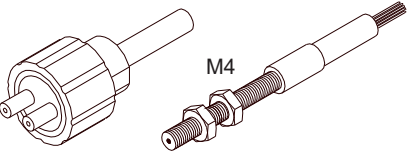

Reflected Light

| Fiber optics | Shape (adaptor and sensor head) | Product description |
|---|--|---|
| <p>R-S-A3.0-(3.0)-600-67° R-S-A3.0-(3.0)-600-22° R-S-A3.0-(3.0)-1200-67° R-S-A3.0-(3.0)-1200-22°</p> | <p>Sheathing type „S“: cf. page 4 Sensor head „A3.0“: cf. page 5 Adaptor: cf. page 7</p> | <p>Reflected light operation (R) Silicone-metal sheath (S) Sensor head A3.0 (fiber bundle Ø 3.0 mm) Total length 600 mm or 1200 mm Beam angle 67° or 22°</p> |
| <p>R-P-B1.1-(0.6)-1200-67° R-P-B1.1-(0.6)-1200-22°</p> |  | <p>Reflected light operation (R) PVC special sheath (P) Sensor head B1.1 (fiber bundle Ø 0.6 mm) Total length 1200 mm Beam angle 67° or 22°</p> |
| <p>R-P-B2.0-(1.0)-1200-67°</p> |  | <p>Reflected light operation (R) PVC special sheath (P) Sensor head B2.0 (fiber bundle Ø 1.0 mm) Total length 1200 mm Beam angle 67°</p> |
| <p>R-P-B3.0-(2.5)-600-67° R-P-B3.0-(2.5)-600-22°</p> | <p>Sheathing type „P“: cf. page 4 Sensor head „B3.0“: cf. page 5 Adaptor: cf. page 7</p> | <p>Reflected light operation (R) PVC special sheath (P) Sensor head B3.0 (fiber bundle Ø 2.5 mm) Total length 600 mm Beam angle 67° or 22°</p> |
| <p>R-E-C1.0-(1.0)-1200-67° R-E-C1.0-(1.0)-1200-22°</p> |  | <p>Reflected light operation (R) Special steel sheath VA (E) Sensor head C1.0 (fiber bundle Ø 1.0 mm) Total length 1200 mm Beam angle 67° or 22°</p> |
| <p>R-M-C1.0-(1.0)-1200-22°</p> |  | <p>Reflected light operation (R) Metal sheath (M) Sensor head C1.0 (fiber bundle Ø 1.0 mm) Total length 1200 mm Beam angle 22°</p> |
| <p>R-S-C1.0-(1.0)-1200-67° R-S-C1.0-(1.0)-1200-22°</p> |  | <p>Reflected light operation (R) Silicone-metal sheath (S) Sensor head C1.0 (fiber bundle Ø 1.0 mm) Total length 1200 mm Beam angle 67° or 22°</p> |

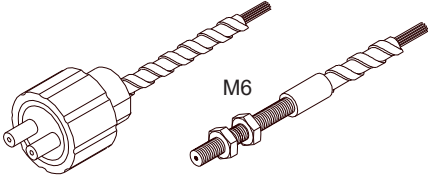
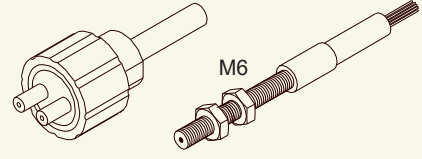
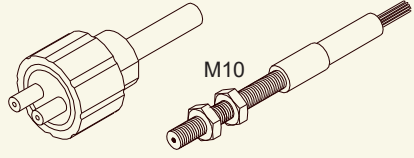
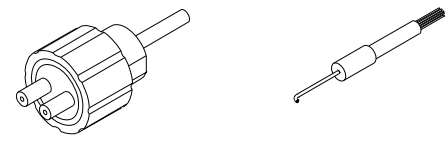

Reflected Light

| Fiber optics | Shape (adaptor and sensor head) | Product description |
|--|--|--|
| <p>R-E-C2.0-(2.5)-1200-67° R-E-C2.0-(2.5)-1200-22°</p> |  | <p>Reflected light operation (R) Special steel sheath VA (E) Sensor head C2.0 (fiber bundle Ø 2.5 mm) Total length 1200 mm Beam angle 67° or 22°</p> |
| <p>R-S-C2.0-(2.5)-600-67° R-S-C2.0-(2.5)-600-22° R-S-C2.0-(2.5)-1200-67° R-S-C2.0-(2.5)-1200-22°</p> |  | <p>Reflected light operation (R) Silicone-metal sheath (S) Sensor head C2.0 (fiber bundle Ø 2.5 mm) Total length 600 mm or 1200 mm Beam angle 67° or 22°</p> |
| <p>R-M-C3.0-(3.0)-1200-67° R-M-C3.0-(3.0)-1200-22°</p> | <p>Sheathing type „M“: cf. page 4 Sensor head „C3.0“: cf. page 5 Adaptor: cf. page 7</p> | <p>Reflected light operation (R) Metal sheath (M) Sensor head C3.0 (fiber bundle Ø 3.0 mm) Total length 1200 mm Beam angle 67° or 22°</p> |
| <p>R-S-C3.0-(3.0)-1200-67° R-S-C3.0-(3.0)-1200-22°</p> |  | <p>Reflected light operation (R) Silicone-metal sheath (S) Sensor head C3.0 (fiber bundle Ø 3.0 mm) Total length 1200 mm Beam angle 67° or 22°</p> |
| <p>R-P-D1.0-(0.6)-1200-67° R-P-D1.0-(0.6)-1200-22°</p> |  | <p>Reflected light operation (R) Silicone-metal sheath (S) Sensor head D1.0 (fiber bundle Ø 0.6 mm) Total length 1200 mm Beam angle 67° or 22°</p> |
| <p>R-P-D1.1-(0.6)-600-22°</p> | <p>Sheathing type „P“: cf. page 4 Sensor head „D1.1“: cf. page 6 Adaptor: cf. page 7</p> | <p>Reflected light operation (R) PVC special sheath (P) Sensor head D1.1 (fiber bundle Ø 0.6 mm) Total length 600 mm Beam angle 22°</p> |
| <p>R-S-D1.1-(0.6)-1200-67° R-S-D1.1-(0.6)-1200-22° R-S-D1.1-(0.6)-1200-67°-VS R-S-D1.1-(0.6)-1200-22°-VS</p> | <p>Sheathing type „S“: cf. page 4 Sensor head „D1.1“: cf. page 6 Adaptor: cf. page 7</p> | <p>Reflected light operation (R) Silicone-metal sheath (S) Sensor head D1.1 (fiber bundle Ø 0.6 mm) Total length 1200 mm Beam angle 67° or 22° Special version with vibration protection (VS)</p> |

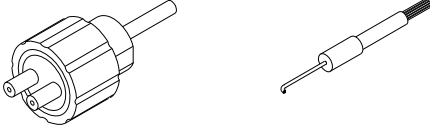
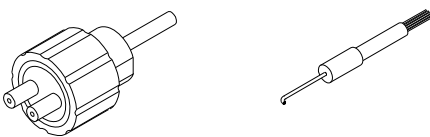
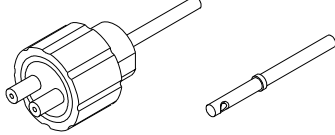
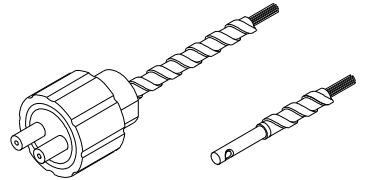
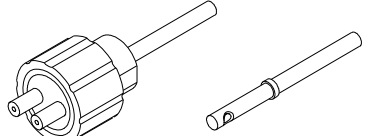

Reflected Light

| Fiber optics | Shape (adaptor and sensor head) | Product description |
|---|--|--|
| <p>R-P-D2.0-(1.5)-1200-67°</p> |  | <p>Reflected light operation (R) PVC special sheath (P) Sensor head D2.0 (fiber bundle Ø 1.5 mm) Total length 1200 mm Beam angle 67°</p> |
| <p>R-S-D3.0-(2.5)-600-67°</p> |  | <p>Reflected light operation (R) Silicone-metal sheath (S) Sensor head D3.0 (fiber bundle Ø 2.5 mm) Total length 600 mm Beam angle 67°</p> |
| <p>R-P-E1.0-(1.5)-600-67° R-P-E1.0-(1.5)-600-22° R-P-E1.0-(1.5)-1200-67° R-P-E1.0-(1.5)-1200-22°</p> |  | <p>Reflected light operation (R) PVC special sheath (P) Sensor head E1.0 (fiber bundle Ø 1.5 mm) Total length 600 mm or 1200 mm Beam angle 67° or 22°</p> |
| <p>R-M-E2.0-(2.5)-600-67° R-M-E2.0-(2.5)-1200-67°</p> |  | <p>Reflected light operation (R) Metal sheath (M) Sensor head E2.0 (fiber bundle Ø 2.5 mm) Total length 600 mm or 1200 mm Beam angle 67°</p> |
| <p>R-P-E2.0-(2.5)-600-67° R-P-E2.0-(2.5)-600-22° R-P-E2.0-(2.5)-1200-67° R-P-E2.0-(2.5)-1200-22°</p> |  | <p>Reflected light operation (R) PVC special sheath (P) Sensor head E2.0 (fiber bundle Ø 2.5 mm) Total length 600 mm or 1200 mm Beam angle 67° or 22°</p> |
| <p>R-S-E2.1-(2.5)-600-67° R-S-E2.1-(2.5)-1200-67°</p> | <p>Sheathing type „S“: cf. page 4 Sensor head „E2.1“: cf. page 5 Adaptor: cf. page 7</p> | <p>Reflected light operation (R) Silicone-metal sheath (S) Sensor head E2.1 (fiber bundle Ø 2.5 mm) Total length 600 mm or 1200 mm Beam angle 67°</p> |
| <p>R-M-E3.0-(3.0)-600-67° R-M-E3.0-(3.0)-1200-67°</p> | <p>Sheathing type „M“: cf. page 4 Sensor head „E3.0“: cf. page 5 Adaptor: cf. page 7</p> | <p>Reflected light operation (R) Metal sheath (M) Sensor head E3.0 (fiber bundle Ø 3.0 mm) Total length 600 mm or 1200 mm Beam angle 67°</p> |

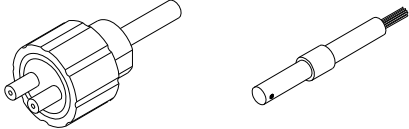

Reflected Light

| Fiber optics | Shape (adaptor and sensor head) | Product description |
|--|---|--|
| R-P-E3.0-(3.0)-600-67° R-P-E3.0-(3.0)-1200-67° | Sheathing type „P“: cf. page 4 Sensor head „E3.0“: cf. page 6 Adaptor: cf. page 7 | Reflected light operation (R) PVC special sheath (P) Sensor head E3.0 (fiber bundle Ø 3.0 mm) Total length 600 mm or 1200 mm Beam angle 67° |
| R-P-F1.0-(1.5)-600-67° R-P-F1.0-(1.5)-1200-67° | Sheathing type „P“: cf. page 4 Sensor head „F1.0“: cf. page 6 Adaptor: cf. page 7 | Reflected light operation (R) PVC special sheath (P) Sensor head F1.0 (fiber bundle Ø 1.5 mm) Total length 600 mm or 1200 mm Beam angle 67° |
| R-S-F1.0-(1.5)-600-67° R-S-F1.0-(1.5)-600-22° R-S-F1.0-(1.5)-1200-67° R-S-F1.0-(1.5)-1200-22° R-S-F1.0-(1.5)-1200-67°-VS R-S-F1.0-(1.5)-1200-22°-VS |  | Reflected light operation (R) Silicone-metal sheath (S) Sensor head F1.0 (fiber bundle Ø 1.5 mm) Total length 600 mm or 1200 mm Beam angle 67° or 22° Special version with vibration protection (VS) |
| R-M-F2.0-(2.5)-600-67° R-M-F2.0-(2.5)-1200-67° R-M-F2.0-(2.5)-600-22° R-M-F2.0-(2.5)-1200-22° | Sheathing type „M“: cf. page 4 Sensor head „F2.0“: cf. page 6 Adaptor: cf. page 7 | Reflected light operation (R) Metal sheath (M) Sensor head F2.0 (fiber bundle Ø 2.5 mm) Total length 600 mm or 1200 mm Beam angle 67° or 22° |
| R-S-F2.0-(2.5)-600-67° R-S-F2.0-(2.5)-1200-67° R-S-F2.0-(2.5)-600-22° R-S-F2.0-(2.5)-1200-22° | Sheathing type „S“: cf. page 4 Sensor head „F2.0“: cf. page 6 Adaptor: cf. page 7 | Reflected light operation (R) Silicone-metal sheath (S) Sensor head F2.0 (fiber bundle Ø 2.5 mm) Total length 600 mm or 1200 mm Beam angle 67° or 22° |
| R-M-F3.0-(3.0)-600-67° R-M-F3.0-(3.0)-1200-67° | Sheathing type „M“: cf. page 4 Sensor head „F3.0“: cf. page 6 Adaptor: cf. page 7 | Reflected light operation (R) Metal sheath (M) Sensor head F3.0 (fiber bundle Ø 3.0 mm) Total length 600 mm or 1200 mm Beam angle 67° |
| R-S-F3.0-(3.0)-600-67° R-S-F3.0-(3.0)-1200-67° | Sheathing type „S“: cf. page 4 Sensor head „F3.0“: cf. page 6 Adaptor: cf. page 7 | Reflected light operation (R) Silicone-metal sheath (S) Sensor head F3.0 (fiber bundle Ø 3.0 mm) Total length 600 mm or 1200 mm Beam angle 67° |

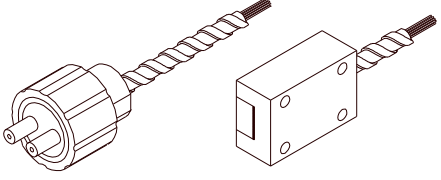
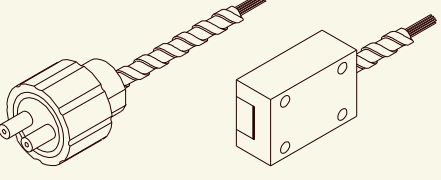
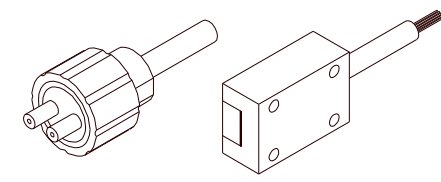
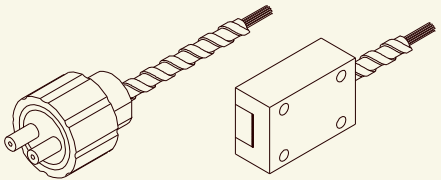
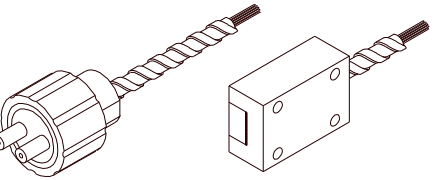

Reflected Light

| Fiber optics | Shape (adaptor and sensor head) | Product description |
|--|--|--|
| <p>R-S-O1.1-(0.6)-1200-67° R-S-O1.1-(0.6)-1200-22°</p> | <p>Sheathing type „S“: cf. page 4 Sensor head „O1.1“: cf. page 6 Adaptor: cf. page 7</p> | <p>Reflected light operation (R) Silicone-metal sheath (S) Sensor head O1.1 (fiber bundle Ø 0.6 mm) Total length 1200 mm Beam angle 67° or 22°</p> |
| <p>R-S-O2.1-(1.0)-1200-67° R-S-O2.1-(1.0)-1200-22°</p> | <p>Sheathing type „S“: cf. page 4 Sensor head „O1.1“: cf. page 6 Adaptor: cf. page 7</p> | <p>Reflected light operation (R) Silicone-metal sheath (S) Sensor head O2.1 (fiber bundle Ø 1.0 mm) Total length 1200 mm Beam angle 67° or 22°</p> |
| <p>R-E-Q2-(10x0.3)-1200-67° R-E-Q2-(10x0.3)-1200-22°</p> |  | <p>Reflected light operation (R) Special steel sheath VA (E) Sensor head Q2 (fiber gap 10 mm x 0.3 mm) Total length 1200 mm Beam angle 67° or 22°</p> |
| <p>R-M-Q2-(10x0.3)-1200-67° R-M-Q2-(10x0.3)-1200-22°</p> |  | <p>Reflected light operation (R) Metal sheath (M) Sensor head Q2 (fiber gap 10 mm x 0.3 mm) Total length 1200 mm Beam angle 67° or 22°</p> |
| <p>R-S-Q2-(10x0.3)-1200-67° R-S-Q2-(10x0.3)-1200-22°</p> |  | <p>Reflected light operation (R) Silicone-metal sheath (S) Sensor head Q2 (fiber gap 10 mm x 0.3 mm) Total length 1200 mm Beam angle 67° or 22°</p> |
| <p>R-E-Q3-(18x0.3)-1200-67° R-E-Q3-(18x0.3)-1200-22°</p> |  | <p>Reflected light operation (R) Special steel sheath VA (E) Sensor head Q3 (fiber gap 18 mm x 0.3 mm) Total length 1200 mm Beam angle 67° or 22°</p> |
| <p>R-M-Q3-(18x0.3)-1200-67° R-M-Q3-(18x0.3)-1200-22°</p> |  | <p>Reflected light operation (R) Metal sheath (M) Sensor head Q3 (fiber gap 18 mm x 0.3 mm) Total length 1200 mm Beam angle 67° or 22°</p> |

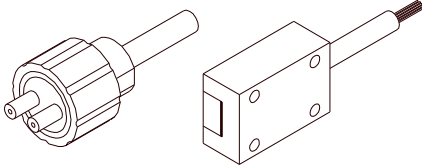
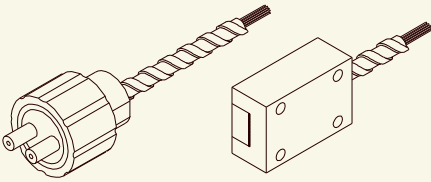
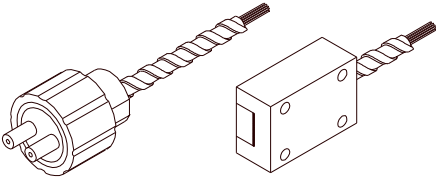
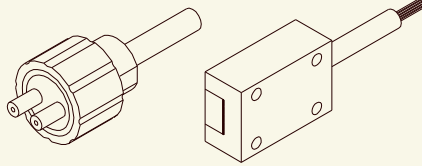
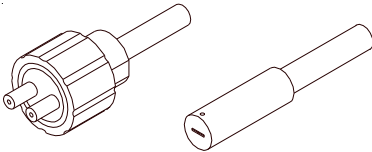
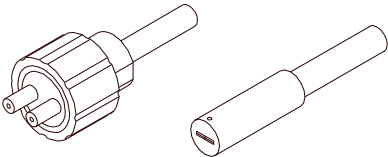

Reflected Light

| Fiber optics | Shape (adaptor and sensor head) | Product description |
|--|--|--|
| <p>R-S-Q3-(18x0.3)-1200-67° R-S-Q3-(18x0.3)-1200-22°</p> |  | <p>Reflected light operation (R) Silicone-metal sheath (S) Sensor head Q3 (fiber gap 18 mm x 0.3 mm) Total length 1200 mm Beam angle 67° or 22°</p> |
| <p>R-E-Q4-(28x0.2)-1200-67° R-E-Q4-(28x0.2)-1200-22°</p> |  | <p>Reflected light operation (R) Special steel sheath VA (E) Sensor head Q4 (fiber gap 28 mm x 0.2 mm) Total length 1200 mm Beam angle 67° or 22°</p> |
| <p>R-M-Q4-(28x0.2)-1200-67° R-M-Q4-(28x0.2)-1200-22°</p> |  | <p>Reflected light operation (R) Metal sheath (M) Sensor head Q4 (fiber gap 28 mm x 0.2 mm) Total length 1200 mm Beam angle 67° or 22°</p> |
| <p>R-S-Q4-(28x0.2)-1200-67° R-S-Q4-(28x0.2)-1200-22°</p> |  | <p>Reflected light operation (R) Silicone-metal sheath (S) Sensor head Q4 (fiber gap 28 mm x 0.2 mm) Total length 1200 mm Beam angle 67° or 22°</p> |
| <p>R-S-R1.1-(3x0.5)-600-67° R-S-R1.1-(3x0.5)-600-22° R-S-R1.1-(3x0.5)-1200-67° R-S-R1.1-(3x0.5)-1200-22° R-S-R1.1-SV-(2x0.2)-600-22°</p> |  | <p>Reflected light operation (R) Silicone-metal sheath (S) Sensor head R1.1 (fiber gap 3 mm x 0.5 mm) Total length 1200 mm Beam angle 67° or 22° Special version SV: Fiber gap 2 mm x 0.2 mm</p> |
| <p>R-M-R2.1-(6x1)-600-67° R-M-R2.1-(6x1)-1200-67°</p> | <p>Sheathing type „M“: cf. page 4 Sensor head „R2.1“: cf. page 6 Adaptor: cf. page 7</p> | <p>Reflected light operation (R) Metal sheath (M) Sensor head R2.1 (fiber gap 6 mm x 1 mm) Total length 1200 mm Beam angle 67°</p> |
| <p>R-S-R2.1-(6x1)-600-67° R-S-R2.1-(6x1)-600-22° R-S-R2.1-(6x1)-1200-67° R-S-R2.1-(6x1)-1200-22° R-S-R2.1-(6x1)-3000-67°</p> |  | <p>Reflected light operation (R) Silicone-metal sheath (S) Sensor head R2.1 (fiber gap 6 mm x 1 mm) Total length 600 mm, 1200 mm, or 3000 mm Beam angle 67° or 22°</p> |



Reflected Light Y-Shape

| Fiber optics | Shape (adaptor and sensor head) | Product description |
|---|--|---|
| <p>R-S-A1.1-(1.5)-1200-Y-67°/67°</p> <p>Suitable for: SPECTRO-3-ELS in connection with SPECTRO-3-FIO</p> | <p>Sheathing type „S“: cf. page 4 Sensor head „A1.1“: cf. page 5 Adaptor: cf. page 7</p> | <p>Reflected light operation (R) Silicone-metal sheath (S) 2x sensor head A1.1 (fiber bundle Ø 1.5 mm) Total length 1200 mm Y-shape: Beam angles 67° and 67°</p> |
| <p>R-S-A2.0-(2.5)-1200-Y-67°/67°</p> <p>Suitable for: SPECTRO-3-ELS in connection with SPECTRO-3-FIO</p> |  | <p>Reflected light operation (R) Silicone-metal sheath (S) 2x sensor head A2.0 (fiber bundle Ø 2.5 mm) Total length 1200 mm Y-shape: Beam angles 67° and 67°</p> |
| <p>R-S-A3.0-(3.0)-1200-Y-67°/67°</p> <p>Suitable for: SPECTRO-3-ELS in connection with SPECTRO-3-FIO</p> | <p>Sheathing type „S“: cf. page 4 Sensor head „A3.0“: cf. page 5 Adaptor: cf. page 7</p> | <p>Reflected light operation (R) Silicone-metal sheath (S) 2x sensor head A3.0 (fiber bundle Ø 3.0 mm) Total length 1200 mm Y-shape: Beam angles 67° and 67°</p> |
| <p>R-S-R1.1-(3x0.5)-1200-Y-67°/67°</p> <p>Suitable for: SPECTRO-3-ELS in connection with SPECTRO-3-FIO</p> |  | <p>Reflected light operation (R) Silicone-metal sheath (S) 2x sensor head R1.1 (fiber gap 3 mm x 0.5 mm) Total length 1200 mm Y-shape: Beam angles 67° and 67°</p> |
| <p>R-S-R2.1-(6x1)-1200-Y-67°/67°</p> <p>Suitable for: SPECTRO-3-ELS in connection with SPECTRO-3-FIO</p> |  | <p>Reflected light operation (R) Silicone-metal sheath (S) 2x sensor head R2.1 (fiber gap 6 mm x 1 mm) Total length 1200 mm Y-shape: Beam angles 67° and 67°</p> |
| <p>R-S-A2.0-(2.5)-Y/SPECTRO-1200-67°</p> <p>Suitable for: SPECTRO-256-FIO</p> |  | <p>Reflected light operation (R) Silicone-metal sheath (S) 2x sensor head A2.0 (fiber gap Ø 2.5 mm) Total length 1200 mm Y-shape: Beam angles 67° and 67°</p> |
| <p>R-S-A2.0-(2.5)-Y/SPECTRO-1200-67°-V1.0</p> <p>Suitable for: LUMI-SPECTRO-FIO-IRL/VIS</p> |  | <p>Reflected light operation (R) Silicone-metal sheath (S) 2x sensor head A2.0 (fiber gap Ø 2.5 mm) Total length 1200 mm Y-shape: Beam angles 67° and 67°</p> |

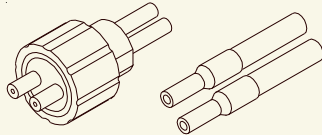
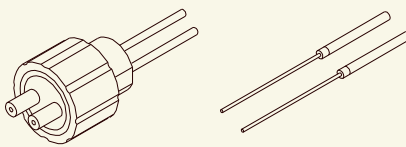

Transmitted Light

| Fiber optics | Shape (adaptor and sensor head) | Product description |
|---|---|--|
| D-E-A1.1-(1.5)-600-67° D-E-A1.1-(1.5)-1200-67° | Sheathing type „E“: cf. page 4 Sensor head „A1.1“: cf. page 5 Adaptor: cf. page 7 | Transmitted light operation (D) Special steel sheath VA (E) Sensor type A1.1 (fiber bundle Ø 1.5 mm) Total length 600 mm or 1200 mm Beam angle 67° |
| D-E-A2.0-(2.5)-600-67° D-E-A2.0-(2.5)-1200-67° D-E-A2.0-(2.5)-4000-67°-T400 | Sheathing type „E“: cf. page 4 Sensor head „A2.0“: cf. page 5 Adaptor: cf. page 7 | Transmitted light operation (D) Special steel sheath VA (E) Sensor type A2.0 (fiber bundle Ø 2.5 mm) Total length 600 mm, 1200 mm, or 4000 mm Beam angle 67° Special version: High temperature stable (T400) |
| D-P-A2.0-(2.5)-600-67° D-P-A2.0-(2.5)-1200-67° | Sheathing type „P“: cf. page 4 Sensor head „A2.0“: cf. page 5 Adaptor: cf. page 7 | Transmitted light operation (D) PVC special sheath (P) Sensor type A2.0 (fiber bundle Ø 2.5 mm) Total length 600 mm or 1200 mm Beam angle 67° |
| D-S-A2.0-(2.5)-600-67° D-S-A2.0-(2.5)-600-22° D-S-A2.0-(2.5)-1200-67° D-S-A2.0-(2.5)-1200-22° D-S-A2.0-(2.5)-3000-67° D-S-A2.0-(2.5)-4500-22°-T400 |  | Transmitted light operation (D) Silicone-metal sheath (S) Sensor type A2.0 (fiber bundle Ø 2.5 mm) Total length 1200 mm Beam angle 67° or 22° Special version: High temperature stable (T400) |
| D-E-A3.0-(3.0)-600-67° | Sheathing type „E“: cf. page 4 Sensor head „A3.0“: cf. page 5 Adaptor: cf. page 7 | Transmitted light operation (D) Metal sheath (M) Sensor type A3.0 (fiber bundle Ø 3.0 mm) Total length 600 mm Beam angle 67° |
| D-P-B1.1-(0.6)-600-67° |  | Transmitted light operation (D) PVC special sheath (P) Sensor type B1.1 (fiber bundle Ø 0.6 mm) Total length 600 mm Beam angle 67° |
| D-P-B3.0-(2.5)-600-67° D-P-B3.0-(2.5)-1200-67° | Sheathing type „P“: cf. page 4 Sensor head „B3.0“: cf. page 5 Adaptor: cf. page 7 | Transmitted light operation (D) PVC special sheath (P) Sensor type B3.0 (fiber bundle Ø 2.5 mm) Total length 600 mm or 1200 mm Beam angle 67° |

Transmitted Light

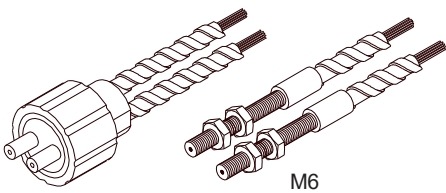
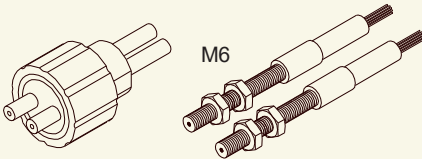
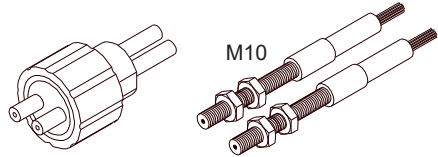
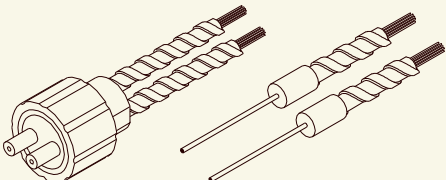
| Fiber optics | Shape (adaptor and sensor head) | Product description |
|---|---|---|
| D-E-C2.0-(2.5)-1200-67° D-E-C2.0-(2.5)-3000-67° D-E-C2.0-(2.5)-1200-22° |  | Transmitted light operation (D) Special steel sheath VA (E) Sensor type C2.0 (fiber bundle Ø 2.5 mm) Total length 1200 mm or 3000 mm Beam angle 67° or 22° |
| D-S-C2.0-(2.5)-1200-67° D-S-C2.0-(2.5)-1200-22° |  | Transmitted light operation (D) Silicone-metal sheath (S) Sensor type C2.0 (fiber bundle Ø 2.5 mm) Total length 1200 mm Beam angle 67° or 22° |
| D-S-C3.0-(3.0)-1200-67° D-S-C3.0-(3.0)-1200-22° |  | Transmitted light operation (D) Silicone-metal sheath (S) Sensor type C3.0 (fiber bundle Ø 3.0 mm) Total length 1200 mm Beam angle 67° or 22° |
| D-M-M1.1-(0.6)-1200-22° |  | Transmitted light operation (D) Metal sheath (M) Sensor type M1.1 (fiber bundle Ø 0.6 mm) Total length 1200 mm Beam angle 22° |
| D-M-Q3-(18x0.3)-600-67° | Sheathing type „M“: cf. page 4 Sensor head „Q3“: cf. page 6 Adaptor: cf. page 7 | Transmitted light operation (D) Metal sheath (M) Sensor type Q3 (fiber gap 18 mm x 0.3 mm) Total length 600 mm Beam angle 67° |
| D-M-Q4-(28x0.2)-600-67° | Sheathing type „M“: cf. page 4 Sensor head „Q4“: cf. page 6 Adaptor: cf. page 7 | Transmitted light operation (D) Metal sheath (M) Sensor type Q4 (fiber gap 28 mm x 0.2 mm) Total length 600 mm Beam angle 67° |
| D-P-Q4-(28x0.2)-600-67° | Sheathing type „M“: cf. page 4 Sensor head „Q4“: cf. page 6 Adaptor: cf. page 7 | Transmitted light operation (D) PVC special sheath (P) Sensor type Q4 (fiber gap 28 mm x 0.2 mm) Total length 600 mm Beam angle 67° |

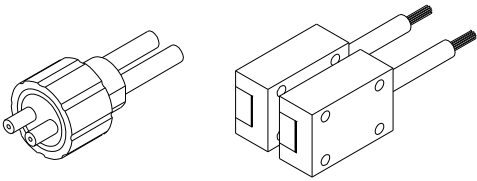
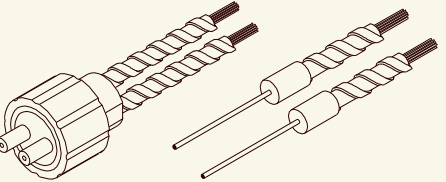
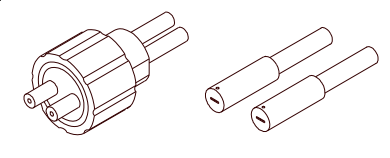
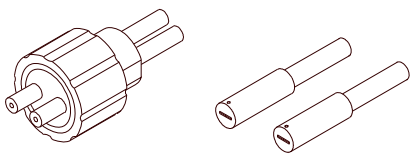

Transmitted Light

| Fiber optics | Shape (adaptor and sensor head) | Product description |
|--|--|--|
| <p>D-S-Q4-(28x0.2)-1200-67° D-S-Q4-(28x0.2)-1200-22°</p> |  | <p>Transmitted light operation (D) Silicone-metal sheath (S) Sensor type Q4 (fiber gap 28 mm x 0.2 mm) Total length 1200 mm Beam angle 67° or 22°</p> |
| <p>D-M-M1.1-(0.6)-1200-22°</p> |  | <p>Transmitted light operation (D) Metal sheath (M) Sensor type M1.1 (fiber gap Ø 0.6 mm) Total length 1200 mm Beam angle 22°</p> |
| <p>D-S-R1.0-(3x0.5)-1200-22°</p> | <p>Sheathing type „S“: cf. page 4 Sensor head „R1.0“: cf. page 6 Adaptor: cf. page 7</p> | <p>Transmitted light operation (D) Silicone-metal sheath (S) Sensor type R1.0 (fiber gap 3 mm x 0.5 mm) Total length 1200 mm Beam angle 22°</p> |
| <p>D-S-R1.1-(3x0.5)-600-67° D-S-R1.1-(3x0.5)-1200-67° D-S-R1.1-(3x0.5)-600-22° D-S-R1.1-(3x0.5)-1200-22° D-S-R1.1-SV-(2x0.2)-600-67°</p> |  | <p>Transmitted light operation (D) Silicone-metal sheath (S) Sensor type R1.1 (fiber gap 3 mm x 0.5 mm) Total length 600 mm or 1200 mm Beam angle 67° or 22° Special version (SV): Fiber gap 2 mm x 0.2 mm</p> |
| <p>D-P-R2.0-(6x1)-1200-67° D-P-R2.0-(6x1)-1200-22° D-P-R2.0-(6x1)-3000-67°</p> | <p>Sheathing type „P“: cf. page 4 Sensor head „R2.0“: cf. page 6 Adaptor: cf. page 7</p> | <p>Transmitted light operation (D) PVC special sheath (P) Sensor type R2.0 (fiber gap 6mm x 1mm) Total length 1200 mm or 3000 mm Beam angle 67° or 22°</p> |
| <p>D-S-R2.0-(6x1)-3000-22°</p> | <p>Sheathing type „S“: cf. page 4 Sensor head „R2.0“: cf. page 6 Adaptor: cf. page 7</p> | <p>Transmitted light operation (D) Silicone-metal sheath (S) Sensor type R2.0 (fiber gap 6mm x 1mm) Total length 3000 mm Beam angle 22°</p> |
| <p>D-S-R2.1-(6x1)-600-67° D-S-R2.1-(6x1)-1200-67° D-S-R2.1-(6x1)-1200-22° D-S-R2.1-(6x1)-3000-67° D-S-R2.1-(6x1)-3000-22°</p> |  | <p>Transmitted light operation (D) Silicone-metal sheath (S) Sensor type R2.1 (fiber gap 6 mm x 1 mm) Total length 600 mm, 1200 mm or 3000 mm Beam angle 67° or 22°</p> |

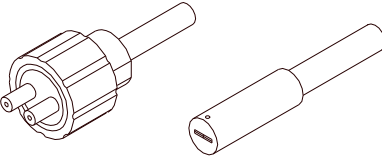

Reflected Light UV

| Fiber optics | Shape (adaptor and sensor head) | Product description |
|---|---|--|
| R-S-A1.1-(1.5)-1200-22°-UV Suitable for: SPECTRO-3-FIO-UV | Sheathing type „S“: cf. page 4 Sensor head „A1.1“: cf. page 5 Adaptor: cf. page 7 | Reflected light operation (R) Silicone-metal sheath (S) Sensor head A1.1 (fiber bundle Ø 1.5 mm) Total length 1200 mm Beam angle 22° UV fibers |
| R-S-A2.0-(2.5)-1200-22°-UV Suitable for: SPECTRO-3-FIO-UV | Sheathing type „S“: cf. page 4 Sensor head „A2.0“: cf. page 5 Adaptor: cf. page 7 | Reflected light operation (R) Silicone-metal sheath (S) Sensor head A2.0 (fiber bundle Ø 2.5 mm) Total length 1200 mm Beam angle 22° UV fibers |
| R-S-A3.0-(3.0)-1200-22°-UV Suitable for: SPECTRO-3-FIO-UV | Sheathing type „S“: cf. page 4 Sensor head „A3.0“: cf. page 5 Adaptor: cf. page 7 | Reflected light operation (R) Silicone-metal sheath (S) Sensor head A3.0 (fiber bundle Ø 3.0 mm) Total length 1200 mm Beam angle 22° UV fibers |
| R-S-R1.1-(3x0.5)-1200-22°-UV Suitable for: SPECTRO-3-FIO-UV |  | Reflected light operation (R) Silicone-metal sheath (S) Sensor head R1.1 (fiber gap 3 mm x 0.5 mm) Total length 1200 mm Beam angle 22° UV fibers |
| R-S-R2.1-(6x1)-1200-22°-UV Suitable for: SPECTRO-3-FIO-UV |  | Reflected light operation (R) Silicone-metal sheath (S) Sensor head R2.1 (fiber gap 6 mm x 1 mm) Total length 1200 mm Beam angle 22° UV fibers |
| D-S-A3.0-(3.0)-600-22°-UV Suitable for: SPECTRO-3-FIO-UV | Sheathing type „S“: cf. page 4 Sensor head „A3.0“: cf. page 5 Adaptor: cf. page 7 | Transmitted light operation (D) Silicone-metal sheath (S) Sensor head A3.0 (fiber gap Ø 3.0 mm) Total length 600 mm Beam angle 22° UV fibers |
| | | |

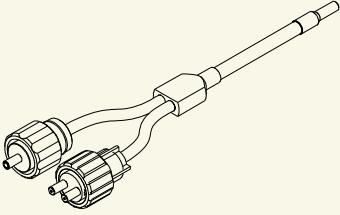
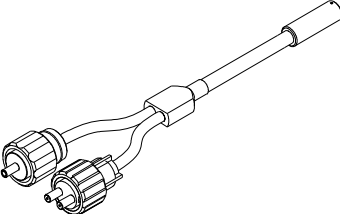
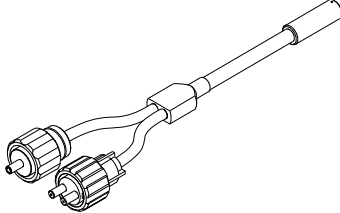

Reflected Light UV 22°/67°

| Fiber optics | Shape (adaptor and sensor head) | Product description |
|--|--|---|
| <p>R-S-A1.1-(1.5)-1200-Y-22°/67°-UV R-S-A1.1-(1.5)-2000-Y-22°/67°-UV</p> <p>Suitable for: SPECTRO-3-ELS-UV in connection with SPECTRO-3-FIO-UV</p> | <p>Sheathing type „S“: cf. page 4 Sensor head „A1.1“: cf. page 5 Adaptor: cf. page 7</p> | <p>Reflected light operation (R) Silicone-metal sheath (S) Sensor head A1.1 (fiber bundle Ø 1.5 mm) Total length 1200 mm or 2000 mm Y-shape: Beam angles 22° and 67° UV fibers</p> |
| <p>R-S-A2.0-(2.5)-1200-Y-22°/67°-UV R-S-A2.0-(2.5)-2000-Y-22°/67°-UV</p> <p>Suitable for: SPECTRO-3-ELS-UV in connection with SPECTRO-3-FIO-UV</p> |  | <p>Reflected light operation (R) Silicone-metal sheath (S) Sensor head A2.0 (fiber bundle Ø 2.5 mm) Total length 1200 mm or 2000 mm Y-shape: Beam angles 22° and 67° UV fibers</p> |
| <p>R-S-A3.0-(3.0)-1200-Y-22°/67°-UV R-S-A3.0-(3.0)-2000-Y-22°/67°-UV</p> <p>Suitable for: SPECTRO-3-ELS-UV in connection with SPECTRO-3-FIO-UV</p> | <p>Sheathing type „S“: cf. page 4 Sensor head „A3.0“: cf. page 5 Adaptor: cf. page 7</p> | <p>Reflected light operation (R) Silicone-metal sheath (S) Sensor head A3.0 (fiber bundle Ø 3.0 mm) Total length 1200 mm or 2000 mm Y-shape: Beam angles 22° and 67° UV fibers</p> |
| <p>R-S-R1.1-(3x0.5)-1200-Y-22°/67°-UV R-S-R1.1-(3x0.5)-3000-Y-22°/67°-UV</p> <p>Suitable for: SPECTRO-3-ELS-UV in connection with SPECTRO-3-FIO-UV</p> |  | <p>Reflected light operation (R) Silicone-metal sheath (S) Sensor head R1.1 (fiber gap 3 mm x 0.5 mm) Total length 1200 mm or 3000 mm Y-shape: Beam angles 22° and 67° UV fibers</p> |
| <p>R-S-R2.1-(6x1)-1200-Y-22°/67°-UV R-S-R2.1-(6x1)-3000-Y-22°/67°-UV</p> <p>Suitable for: SPECTRO-3-ELS-UV in connection with SPECTRO-3-FIO-UV</p> |  | <p>Reflected light operation (R) Silicone-metal sheath (S) Sensor head R2.1 (fiber gap 6 mm x 1 mm) Total length 1200 mm or 3000 mm Y-shape: Beam angles 22° and 67° UV fibers</p> |

Schematic drawing, exemplary R-S-R2.1-(6x1)-1200-Y-22°/67°-UV:

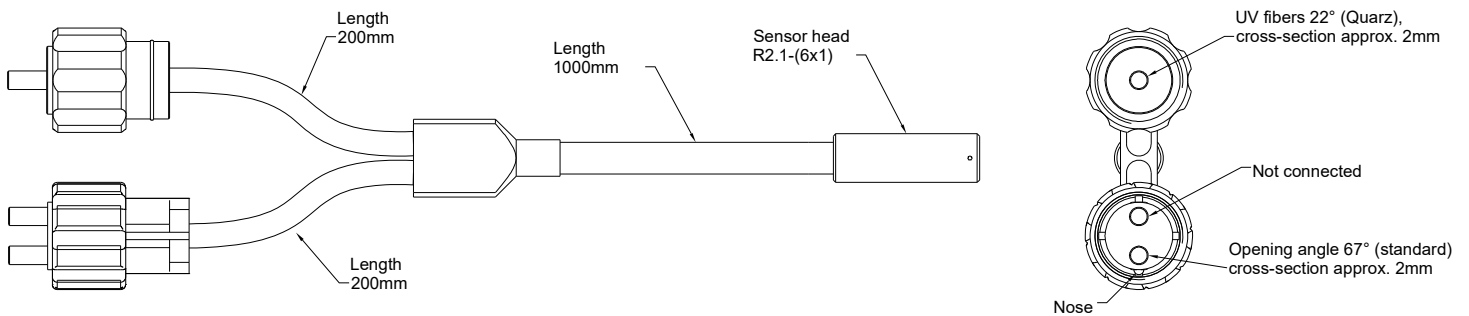



Reflected Light UV 22°/67°/67°

| Fiber optics | Shape (adaptor and sensor head) | Product description |
|---|---------------------------------|--|
| <p>R-S-A1.1-(1.5)-2000-Y-22°/67°/67°-UV</p> <p>Suitable for: SPECTRO-3-ELS-UV in connecting with SPECTRO-3-FIO-VISUV</p> | | <p>Reflected light operation (R) Silicone-metal sheath (S) Sensor head A1.1 (fiber bundle Ø 1.5 mm) Total length 2000 mm Y-shape: Beam angles 22°/67° and 67° UV fibers</p> |
| <p>R-S-A2.0-(2.5)-1200-Y-22°/67°/67°-UV</p> <p>Suitable for: SPECTRO-3-ELS-UV in connection with SPECTRO-3-FIO-VISUV</p> | | <p>Reflected light operation (R) Silicone-metal sheath (S) Sensor head A2.0 (fiber bundle Ø 2.5 mm) Total length 1200 mm Y-shape: Beam angles 22°/67° and 67° UV fibers</p> |
| <p>R-S-A3.0-(3.0)-2000-Y-22°/67°/67°-UV</p> <p>Suitable for: SPECTRO-3-ELS-UV in connection with SPECTRO-3-FIO-VISUV</p> | | <p>Reflected light operation (R) Silicone-metal sheath (S) Sensor head A3.0 (fiber bundle Ø 3.0 mm) Total length 2000 mm Y-shape: Beam angles 22°/67° and 67° UV fibers</p> |

Schematic drawing, exemplary R-S-A3.0-(3.0)-2000-Y-22°/67°/67°-UV:

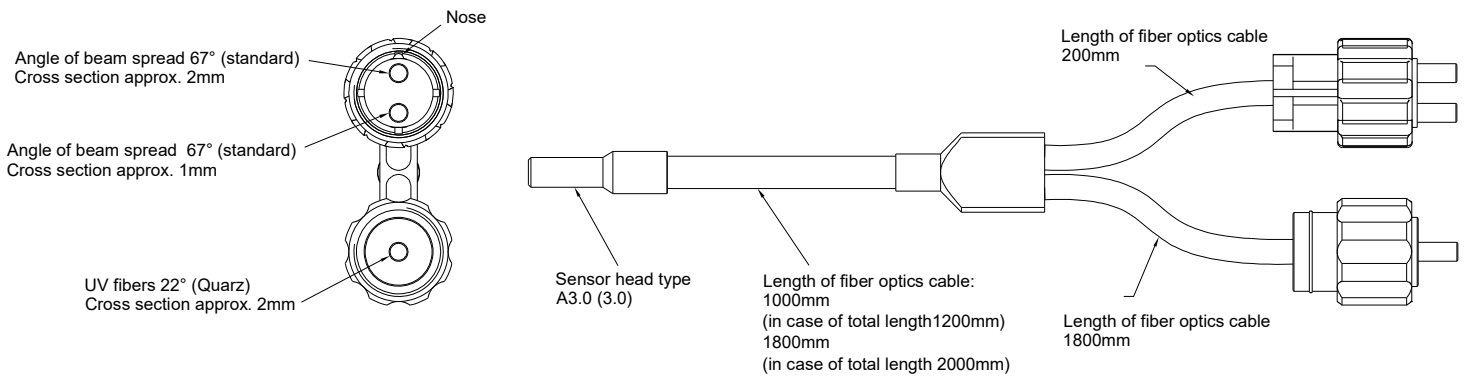

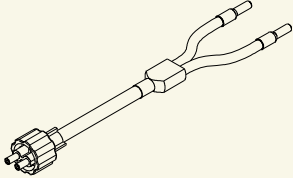

Special Optical Fibers X

| Fiber optics | Shape (adaptor and sensor head) | Product description |
|--------------------------------|---|---|
| X-S-A1.1-(1.5)-2000-67° | Sheathing type „S“: cf. page 4 Sensor head „A1.1“: cf. page 5 Adaptor: cf. page 7 | Fiber optics with two sensor heads, fibers arranged crosswise , Silicone-metal sheath (S) Sensor head A1.1 (fiber bundle Ø 1.5 mm) Total length 2000 mm, beam angle 67° |
| X-S-A2.0-(2.5)-1200-67° |  | Fiber optics with two sensor heads, fibers arranged crosswise , Silicone-metal sheath (S) Sensor head A2.0 (fiber bundle Ø 2.5 mm) Total length 1200 mm, beam angle 67° |
| X-S-F1.0-(1.5)-1200-67° | Sheathing type „S“: cf. page 4 Sensor head „F1.0“: cf. page 6 Adaptor: cf. page 7 | Fiber optics with two sensor heads, fibers arranged crosswise , Silicone-metal sheath (S) Sensor head F1.0 (fiber bundle Ø 1.5 mm) Total length 1200 mm, beam angle 67° |
| X-S-F2.0-(1.5)-1200-67° | Sheathing type „S“: cf. page 4 Sensor head „F2.0“: cf. page 6 Adaptor: cf. page 7 | Fiber optics with two sensor heads, fibers arranged crosswise , Silicone-metal sheath (S) Sensor head F2.0 (fiber bundle Ø 2.5 mm) Total length 1200 mm, beam angle 67° |

Schematic drawing:

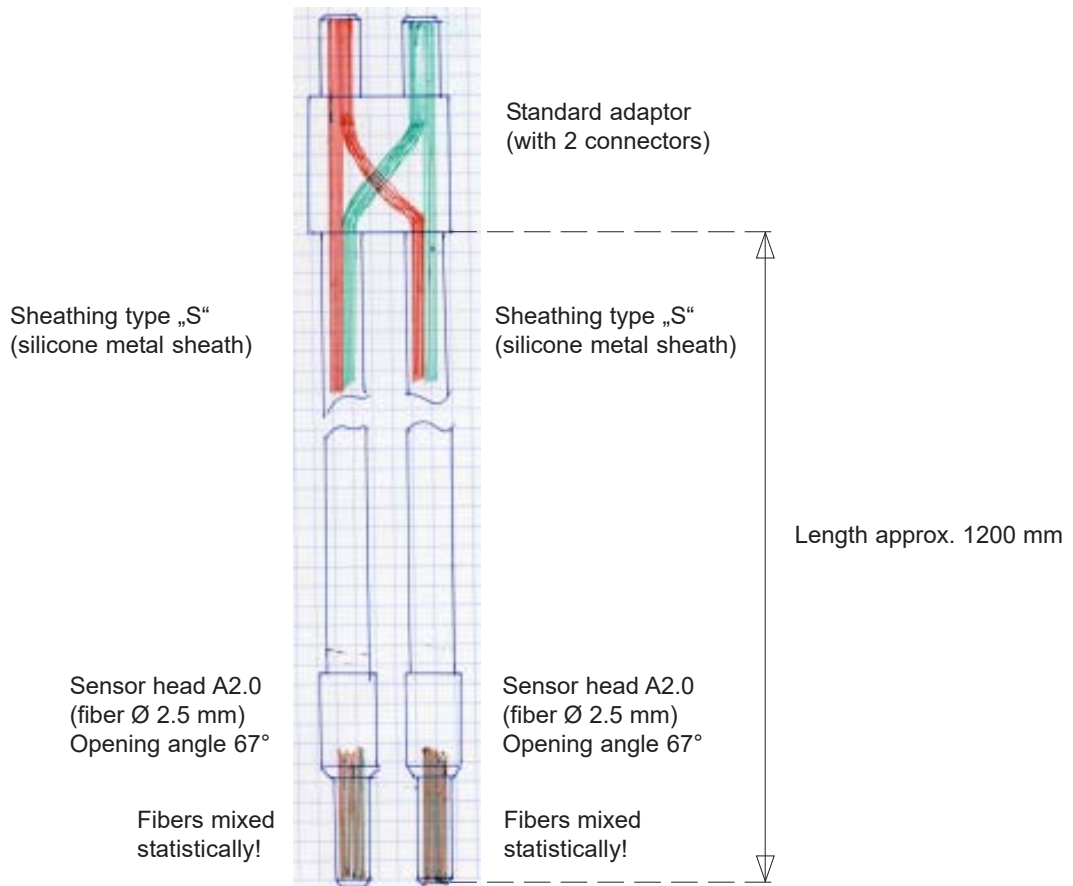



Optical Frontends

Overview: Optical frontends for fiber optics:



KL-1
(A2.0)



KL-2
(A2.0)



KL-3 (A2.0)
KL-4 (A1.1)
KL-5 (R1.1)
KL-8 (R2.1)
KL-9 (A3.0)



KL-90 (2x)
(D-A2.0)



KL-D-2.5
(D-S-A2.0)



KL-D-6
(D-S-A2.0)



KL-D-14
(D-S-A2.0)



KL-D-17
(D-S-A2.0)



KL-D-20
(D-S-A2.0)



KL-D-28
(D-S-A2.0)



KL-D-30
(D-S-A2.0)



KL-D-40
(D-S-A2.0)



KL-M8-A1.1



KL-M12-A1.1
KL-M12-A2.0
KL-M12-A3.0
KL-M12-R1.1



KL-M12-XL-A1.1
KL-M12-XL-A2.0
KL-M12-XL-R1.1



KL-M18-A1.1
KL-M18-A2.0
KL-M18-A3.0
KL-M18-R1.1
KL-M18-R2.1



KL-M18-XL-A1.1
KL-M18-XL-A2.0
KL-M18-XL-A3.0
KL-M18-XL-R1.1
KL-M18-XL-R2.1



KL-M34-A1.1
KL-M34-A2.0
KL-M34-A3.0
KL-M34-R1.1
KL-M34-R2.1



KL-M34-XL-A1.1
KL-M34-XL-A2.0
KL-M34-XL-A3.0
KL-M34-XL-R1.1
KL-M34-XL-R2.1



KL-M34/62-A1.1
KL-M34/62-A2.0
KL-M34/62-A3.0
KL-M34/62-R1.1
KL-M34/62-R2.1



Optical frontends for reflected light or transmitted light fiber optics:

| Part number: | Suitable for fiber optics type: (R, T = reflected light, D= transmitted light) | Characteristics: |
|--------------------------|---|--|
| KL-1 (2 pcs. necessary) | D-S-A2.0-(2.5)-...-67° or 22° | Transmitter/receiver distance typ. 50 mm ... 200 mm |
| KL-2 | R-S-A2.0-(2.5)-...-67° or 22° | Transmitter/receiver distance max. 300 mm, beam divergency ± 7,5° |
| KL-2 (2 pcs. necessary) | D-S-A2.0-(2.5)-...-67° or 22° | Transmitter/receiver distance max. 300 mm, beam divergency ± 7,5° |
| KL-3 | R-S-A2.0-(2.5)-...-67° or 22° | Working distance typ. 10 mm ... 20 mm |
| KL-3/30 | R/D-S-A2.0-(2.5)-1200-67° <i>Special version*</i> | Working distance typ. 30 mm |
| KL-4 | R-S-A1.1-(0.6)-...-67° or 22° | Working distance typ. 10 mm ... 15 mm |
| KL-4 | R-S-A1.1-(1.1)-...-67° or 22° | Working distance typ. 10 mm ... 15 mm |
| KL-4 | R-S-A1.1-(1.5)-...-67° or 22° | Working distance typ. 10 mm ... 15 mm |
| KL-5 | R-S-R1.1-(3x0.5)-...-67° or 22° | Working distance typ. 8 mm ... 20 mm |
| KL-8 | R-S-R2.1-(6x1)-...-67° or 22° | Working distance typ. 8 mm ... 25 mm |
| KL-8-N | R-S-R2.1-(6x1)-...-67° or 22° | Working distance typ. 8 mm ... 25 mm <i>with guide slot (adjustment aid)</i> |
| KL-9 | R-S-A3.0-(3.0)-...-67° or 22° | Working distance typ. 8 mm ... 25 mm |
| KL-90 (2 pcs. necessary) | D-S-A2.0-(2.5)-...-67° or 22° | Working distance typ. 20 mm ... 100 mm - <i>prismatic optics</i> |
| KL-D-2.5 | D-S-A2.0-(2.5)-...-67° | Working distance typ. 100 mm ... 500 mm |
| KL-D-6 | D-S-A2.0-(2.5)-...-67° | Working distance typ. 100 mm ... 230 mm |
| KL-D-14 | D-S-A2.0-(2.5)-...-67° | Working distance typ. 60 mm ... 120 mm |
| KL-D-14-T400 | D-S-A2.0-(2.5)-1200-67°-T400 | Working distance typ. 60 mm ... 120 mm <i>thermally stable up to 400°C</i> |
| KL-D-17 | D-S-A2.0-(2.5)-...-67° | Working distance typ. 30 mm ... 80 mm |
| KL-D-20 | D-S-A2.0-(2.5)-...-67° | Working distance typ. 10 mm ... 50 mm |
| KL-D-28 | D-S-A2.0-(2.5)-...-67° | Working distance typ. 20 mm ... 50 mm |
| KL-D-30 | D-S-A2.0-(2.5)-...-67° | Working distance typ. 20 mm ... 30 mm |
| KL-D-40 | D-S-A2.0-(2.5)-...-67° | Working distance typ. 15 mm ... 25 mm |
| KL-M8-A1.1 | R-S-A1.1-(1.5)-...-67° | Working distance typ. 8 mm ... 20 mm |
| KL-M12-A1.1 | R-S-A1.1-(1.5)-...-67° | Working distance typ. 8 mm ... 40 mm |
| KL-M12-A2.0 | R-S-A2.0-(2.5)-...-67° | Working distance typ. 8 mm ... 40 mm |
| KL-M12-A3.0 | R-S-A3.0-(3.0)-...-67° | Working distance typ. 8 mm ... 40 mm |
| KL-M12-R1.1 | R-S-R1.1-(3x0.5)-...-67° <i>Special version*</i> | Working distance typ. 8 mm ... 40 mm |
| KL-M12-XL-A1.1 | R-S-A1.1-(1.5)-...-67° | Working distance typ. 20 mm ... 100 mm |
| KL-M12-XL-A2.0 | R-S-A2.0-(2.5)-...-67° | Working distance typ. 20 mm ... 100 mm |
| KL-M12-XL-R1.1 | R-S-R1.1-(3x0.5)-...-67° | Working distance typ. 20 mm ... 100 mm |
| KL-M12-XL-30°/30-A2.0 | D-S-A2.0-30°/30-A2.0 | Working distance typ. 20 mm ... 100 mm |
| KL-M18-A1.1 | R-S-A1.1-(1.5)-...-67° | Working distance typ. 20 mm ... 60 mm |
| KL-M18-A2.0 | R-S-A2.0-(2.5)-...-67° | Working distance typ. 20 mm ... 60 mm |
| KL-M18-A3.0 | R-S-A3.0-(3.0)-...-67° | Working distance typ. 20 mm ... 60 mm |
| KL-M18-M5.0 | T-S-M5.0-(5.0)-...-67° <i>Special version*</i> | Working distance typ. 20 mm ... 60 mm |
| KL-M18-M6.0 | T-S-M6.0-(6.0)-...-67° <i>Special version*</i> | Working distance typ. 20 mm ... 60 mm |
| KL-M18-M8.0 | T-S-M8.0-(8.0)-...-67° <i>Special version*</i> | Working distance typ. 20 mm ... 60 mm |
| KL-M18-R1.1 | R-S-R1.1-(3x0.5)-...-67° | Working distance typ. 20 mm ... 60 mm |
| KL-M18-R2.1 | R-S-R2.1-(6x1)-...-67° | Working distance typ. 20 mm ... 60 mm |

*Special version:

Version is different to the standard version (e.g. no standard fiber adapter) and therefore is suitable only for certain sensors or applications



Optical frontends for reflected light or transmitted light fiber optics:

| Part number: | Suitable for fiber optics type: (R, T = reflected light, D= transmitted light) | Characteristics: |
|----------------|---|---|
| KL-M18-XL-A1.1 | R-S-A1.1-(1.5)-...-67° | Working distance typ. 10 mm ... 200 mm |
| KL-M18-XL-A2.0 | R-S-A2.0-(2.5)-...-67° | Working distance typ. 10 mm ... 200 mm |
| KL-M18-XL-A3.0 | R-S-A3.0-(3.0)-...-67° | Working distance typ. 10 mm ... 200 mm |
| KL-M18-XL-M5.0 | T-S-M5.0-(5.0)-...-67° <i>Special version*</i> | Working distance typ. 10 mm ... 200 mm |
| KL-M18-XL-M6.0 | T-S-M6.0-(6.0)-...-67° <i>Special version*</i> | Working distance typ. 10 mm ... 200 mm |
| KL-M18-XL-M8.0 | T-S-M8.0-(8.0)-...-67° <i>Special version*</i> | Working distance typ. 10 mm ... 200 mm |
| KL-M18-XL-R1.1 | R-S-R1.1-(3x0.5)-...-67° | Working distance typ. 10 mm ... 200 mm |
| KL-M18-XL-R2.1 | R-S-R2.1-(6x1)-...-67° | Working distance typ. 10 mm ... 200 mm |
| KL-M34-A1.1 | R-S-A1.1-(1.5)-...-67° | Working distance typ. 100 mm ... 250 mm |
| KL-M34-A2.0 | R-S-A2.0-(2.5)-...-67° | Working distance typ. 100 mm ... 250 mm |
| KL-M34-A3.0 | R-S-A3.0-(3.0)-...-67° | Working distance typ. 100 mm ... 250 mm |
| KL-M34-M5.0 | T-S-M5.0-(5.0)-...-67° <i>Special version*</i> | Working distance typ. 100 mm ... 250 mm |
| KL-M34-M6.0 | T-S-M6.0-(6.0)-...-67° <i>Special version*</i> | Working distance typ. 100 mm ... 250 mm |
| KL-M34-M8.0 | T-S-M8.0-(8.0)-...-67° <i>Special version*</i> | Working distance typ. 100 mm ... 250 mm |
| KL-M34-R1.1 | R-S-R1.1-(3x0.5)-...-67° | Working distance typ. 100 mm ... 250 mm |
| KL-M34-R2.1 | R-S-R2.1-(6x1)-...-67° | Working distance typ. 100 mm ... 250 mm |
| KL-M34-XL-A1.1 | R-S-A1.1-(1.5)-...-67° | Working distance typ. 50 mm ... 400 mm |
| KL-M34-XL-A2.0 | R-S-A2.0-(2.5)-...-67° | Working distance typ. 50 mm ... 400 mm |
| KL-M34-XL-A3.0 | R-S-A3.0-(3.0)-...-67° | Working distance typ. 50 mm ... 400 mm |
| KL-M34-XL-M5.0 | T-S-M5.0-(5.0)-...-67° <i>Special version*</i> | Working distance typ. 50 mm ... 400 mm |
| KL-M34-XL-M6.0 | T-S-M6.0-(6.0)-...-67° <i>Special version*</i> | Working distance typ. 50 mm ... 400 mm |
| KL-M34-XL-M8.0 | T-S-M8.0-(8.0)-...-67° <i>Special version*</i> | Working distance typ. 50 mm ... 400 mm |
| KL-M34-XL-R1.1 | R-S-R1.1-(3x0.5)-...-67° | Working distance typ. 50 mm ... 400 mm |
| KL-M34-XL-R2.1 | R-S-R2.1-(6x1)-...-67° | Working distance typ. 50 mm ... 400 mm |
| KL-M34/62-A1.1 | R-S-A1.1-(1.5)-...-67° | Working distance typ. 80 mm ... 200 mm |
| KL-M34/62-A2.0 | R-S-A2.0-(2.5)-...-67° | Working distance typ. 80 mm ... 200 mm |
| KL-M34/62-A3.0 | R-S-A3.0-(3.0)-...-67° | Working distance typ. 80 mm ... 200 mm |
| KL-M34/62-R1.1 | R-S-R1.1-(3x0.5)-...-67° | Working distance typ. 80 mm ... 200 mm |
| KL-M34/62-R2.1 | R-S-R2.1-(6x1)-...-67° | Working distance typ. 80 mm ... 200 mm |

*Special version:

Version is different to the standard version (e.g. no standard fiber adapter) and therefore is suitable only for certain sensors or applications

Optical Frontends

Optical frontends for reflected light fiber optics in Y-shape (67°/67°, for use with an external light source):

| Part number: | Suitable for fiber optics type: (R = reflected light) | Characteristics: |
|----------------|--|-------------------------------------|
| KL-3 | R-S-A2.0-(2.5)-1200-Y-67°/67° | Working range typ. 10 mm ... 20 mm |
| KL-4 | R-S-A1.1-(1.5)-1200-Y-67°/67° | Working range typ. 10 mm ... 15 mm |
| KL-5 | R-S-R1.1-(3x0.5)-1200-Y-67°/67° | Working range typ. 8 mm ... 20 mm |
| KL-8 | R-S-R2.1-(6x1)-1200-Y-67°/67° | Working range typ. 8 mm ... 25 mm |
| KL-9 | R-S-A3.0-(3.0)-1200-Y-67°/67° | Working range typ. 8 mm ... 25 mm |
| KL-M8-A1.1 | R-S-A1.1-(1.5)-1200-Y-67°/67° | Working range typ. 8 mm ... 20 mm |
| KL-M12-A1.1 | R-S-A1.1-(1.5)-1200-Y-67°/67° | Working range typ. 8 mm ... 20 mm |
| KL-M12-A2.0 | R-S-A2.0-(2.0)-1200-Y-67°/67° | Working range typ. 8 mm ... 20 mm |
| KL-M12-A3.0 | R-S-A3.0-(3.0)-1200-Y-67°/67° | Working range typ. 8 mm ... 20 mm |
| KL-M12-R1.1 | R-S-R1.1-(3x0.5)-1200-Y-67°/67° | Working range typ. 8 mm ... 20 mm |
| KL-M12-XL-A1.1 | R-S-A1.1-(1.5)-1200-Y-67°/67° | Working range typ. 30 mm ... 200 mm |
| KL-M12-XL-A2.0 | R-S-A2.0-(2.0)-1200-Y-67°/67° | Working range typ. 30 mm ... 200 mm |
| KL-M12-XL-R1.1 | R-S-R1.1-(3x0.5)-1200-Y-67°/67° | Working range typ. 30 mm ... 200 mm |
| KL-M18-A1.1 | R-S-A1.1-(1.5)-1200-Y-67°/67° | Working range typ. 10 mm ... 60 mm |
| KL-M18-A2.0 | R-S-A2.0-(2.0)-1200-Y-67°/67° | Working range typ. 10 mm ... 80 mm |
| KL-M18-A3.0 | R-S-A3.0-(3.0)-1200-Y-67°/67° | Working range typ. 10 mm ... 80 mm |
| KL-M18-R1.1 | R-S-R1.1-(3x0.5)-1200-Y-67°/67° | Working range typ. 10 mm ... 60 mm |
| KL-M18-R2.1 | R-S-R2.1-(6x1)-1200-Y-67°/67° | Working range typ. 10 mm ... 80 mm |
| KL-M18-XL-A1.1 | R-S-A1.1-(1.5)-1200-Y-67°/67° | Working range typ. 50 mm ... 300 mm |
| KL-M18-XL-A2.0 | R-S-A2.0-(2.0)-1200-Y-67°/67° | Working range typ. 50 mm ... 300 mm |
| KL-M18-XL-A3.0 | R-S-A3.0-(3.0)-1200-Y-67°/67° | Working range typ. 50 mm ... 300 mm |
| KL-M18-XL-R1.1 | R-S-R1.1-(3x0.5)-1200-Y-67°/67° | Working range typ. 50 mm ... 300 mm |
| KL-M18-XL-R2.1 | R-S-R2.1-(6x1)-1200-Y-67°/67° | Working range typ. 50 mm ... 300 mm |
| KL-M34-A1.1 | R-S-A1.1-(1.5)-1200-Y-67°/67° | Working range typ. 50 mm ... 200 mm |
| KL-M34-A2.0 | R-S-A2.0-(2.0)-1200-Y-67°/67° | Working range typ. 50 mm ... 250 mm |
| KL-M34-A3.0 | R-S-A3.0-(3.0)-1200-Y-67°/67° | Working range typ. 50 mm ... 300 mm |
| KL-M34-R1.1 | R-S-R1.1-(3x0.5)-1200-Y-67°/67° | Working range typ. 50 mm ... 200 mm |
| KL-M34-R2.1 | R-S-R2.1-(6x1)-1200-Y-67°/67° | Working range typ. 50 mm ... 300 mm |
| KL-M34/62-A1.1 | R-S-A1.1-(1.5)-1200-Y-67°/67° | Working range typ. 80 mm ... 200 mm |
| KL-M34/62-A2.0 | R-S-A2.0-(2.0)-1200-Y-67°/67° | Working range typ. 80 mm ... 200 mm |
| KL-M34/62-A3.0 | R-S-A3.0-(3.0)-1200-Y-67°/67° | Working range typ. 80 mm ... 200 mm |
| KL-M34/62-R1.1 | R-S-R1.1-(3x0.5)-1200-Y-67°/67° | Working range typ. 80 mm ... 200 mm |
| KL-M34/62-R2.1 | R-S-R2.1-(6x1)-1200-Y-67°/67° | Working range typ. 80 mm ... 200 mm |



Optical Frontends

Optical frontends for UV fiber optics (22°-UV) or UV fiber optics in Y-shape (22°/67°-UV, used with external UV light source):

| Part number: | Suitable for UV fiber optics type: (R = reflected light) | Characteristics: |
|----------------|---|--|
| KL-3 | R-S-A2.0-(2.5)-1200-22°-UV | Working distance typ. 10 mm ... 20 mm |
| | R-S-A2.0-(2.5)-1200-Y-22°/67°-UV | Working distance typ. 10 mm ... 20 mm |
| KL-4 | R-S-A1.1-(1.5)-1200-22°-UV | Working distance typ. 10 mm ... 15 mm |
| | R-S-A1.1-(1.5)-1200-Y-22°/67°-UV | Working distance typ. 10 mm ... 15 mm |
| KL-5 | R-S-R1.1-(3x0.5)-1200-22°-UV | Working distance typ. 8 mm ... 20 mm |
| | R-S-R1.1-(3x0.5)-1200-Y-22°/67°-UV | Working distance typ. 8 mm ... 20 mm |
| KL-8 | R-S-R2.1-(6x1)-1200-22°-UV | Working distance typ. 8 mm ... 25 mm |
| | R-S-R2.1-(6x1)-1200-Y-22°/67°-UV | Working distance typ. 8 mm ... 25 mm |
| KL-9 | R-S-A3.0-(3.0)-1200-22°-UV | Working distance typ. 8 mm ... 25 mm |
| | R-S-A3.0-(3.0)-1200-Y-22°/67°-UV | Working distance typ. 8 mm ... 25 mm |
| KL-M8-A1.1 | R-S-A1.1-(1.5)-1200-22°-UV | Working distance typ. 8 mm ... 20 mm |
| | R-S-A1.1-(1.5)-1200-Y-22°/67°-UV | Working distance typ. 8 mm ... 20 mm |
| KL-M12-A1.1 | R-S-A1.1-(1.5)-1200-22°-UV | Working distance typ. 8 mm ... 20 mm |
| | R-S-A1.1-(1.5)-1200-Y-22°/67°-UV | Working distance typ. 8 mm ... 20 mm |
| KL-M12-A2.0 | R-S-A2.0-(2.5)-1200-22°-UV | Working distance typ. 8 mm ... 20 mm |
| | R-S-A2.0-(2.5)-1200-Y-22°/67°-UV | Working distance typ. 8 mm ... 20 mm |
| KL-M12-A3.0 | R-S-A3.0-(3.0)-1200-22°-UV | Working distance typ. 8 mm ... 20 mm |
| | R-S-A3.0-(3.0)-1200-Y-22°/67°-UV | Working distance typ. 8 mm ... 20 mm |
| KL-M12-R1.1 | R-S-R1.1-(3x0.5)-1200-22°-UV | Working distance typ. 8 mm ... 20 mm |
| | R-S-R1.1-(3x0.5)-1200-Y-22°/67°-UV | Working distance typ. 8 mm ... 20 mm |
| KL-M12-XL-A1.1 | R-S-A1.1-(1.5)-1200-22°-UV | Working distance typ. 30 mm ... 200 mm |
| | R-S-A1.1-(1.5)-1200-Y-22°/67°-UV | Working distance typ. 30 mm ... 200 mm |
| KL-M12-XL-A2.0 | R-S-A2.0-(2.5)-1200-22°-UV | Working distance typ. 30 mm ... 200 mm |
| | R-S-A2.0-(2.5)-1200-Y-22°/67°-UV | Working distance typ. 30 mm ... 200 mm |
| KL-M12-XL-R1.1 | R-S-R1.1-(3x0.5)-1200-22°-UV | Working distance typ. 30 mm ... 200 mm |
| | R-S-R1.1-(3x0.5)-1200-Y-22°/67°-UV | Working distance typ. 30 mm ... 200 mm |
| KL-M18-A1.1 | R-S-A1.1-(1.5)-1200-22°-UV | Working distance typ. 10 mm ... 60 mm |
| | R-S-A1.1-(1.5)-1200-Y-22°/67°-UV | Working distance typ. 10 mm ... 60 mm |
| KL-M18-A2.0 | R-S-A2.0-(2.5)-1200-22°-UV | Working distance typ. 10 mm ... 80 mm |
| | R-S-A2.0-(2.5)-1200-Y-22°/67°-UV | Working distance typ. 10 mm ... 80 mm |
| KL-M18-A3.0 | R-S-A3.0-(3.0)-1200-22°-UV | Working distance typ. 10 mm ... 80 mm |
| | R-S-A3.0-(3.0)-1200-Y-22°/67°-UV | Working distance typ. 10 mm ... 80 mm |
| KL-M18-R1.1 | R-S-R1.1-(3x0.5)-1200-22°-UV | Working distance typ. 10 mm ... 60 mm |
| | R-S-R1.1-(3x0.5)-1200-Y-22°/67°-UV | Working distance typ. 10 mm ... 60 mm |
| KL-M18-R2.1 | R-S-R2.1-(6x1)-1200-22°-UV | Working distance typ. 10 mm ... 80 mm |
| | R-S-R2.1-(6x1)-1200-Y-22°/67°-UV | Working distance typ. 10 mm ... 80 mm |



Optical Frontends

Optical frontends for UV fiber optics (22°-UV) or UV fiber optics in Y-shape (22°/67°-UV, used with external UV light source):

| Part number: | Suitable for UV fiber optics type: (R = reflected light) | Characteristics: |
|----------------|---|--|
| KL-M18-XL-A1.1 | R-S-A1.1-(1.5)-1200-22°-UV | Working distance typ. 50 mm ... 300 mm |
| | R-S-A1.1-(1.5)-1200-Y-22°/67°-UV | Working distance typ. 50 mm ... 300 mm |
| KL-M18-XL-A2.0 | R-S-A2.0-(2.5)-1200-22°-UV | Working distance typ. 50 mm ... 300 mm |
| | R-S-A2.0-(2.5)-1200-Y-22°/67°-UV | Working distance typ. 50 mm ... 300 mm |
| KL-M18-XL-A3.0 | R-S-A3.0-(3.0)-1200-22°-UV | Working distance typ. 50 mm ... 300 mm |
| | R-S-A3.0-(3.0)-1200-Y-22°/67°-UV | Working distance typ. 50 mm ... 300 mm |
| KL-M18-XL-R1.1 | R-S-R1.1-(3x0.5)-1200-22°-UV | Working distance typ. 50 mm ... 300 mm |
| | R-S-R1.1-(3x0.5)-1200-Y-22°/67°-UV | Working distance typ. 50 mm ... 300 mm |
| KL-M18-XL-R2.1 | R-S-R2.1-(6x1)-1200-22°-UV | Working distance typ. 50 mm ... 300 mm |
| | R-S-R2.1-(6x1)-1200-Y-22°/67°-UV | Working distance typ. 50 mm ... 300 mm |
| | | |
| KL-M34-A1.1 | R-S-A1.1-(1.5)-1200-22°-UV | Working distance typ. 50 mm ... 200 mm |
| | R-S-A1.1-(1.5)-1200-Y-22°/67°-UV | Working distance typ. 50 mm ... 200 mm |
| KL-M34-A2.0 | R-S-A2.0-(2.5)-1200-22°-UV | Working distance typ. 50 mm ... 250 mm |
| | R-S-A2.0-(2.5)-1200-Y-22°/67°-UV | Working distance typ. 50 mm ... 250 mm |
| KL-M34-A3.0 | R-S-A3.0-(3.0)-1200-22°-UV | Working distance typ. 50 mm ... 300 mm |
| | R-S-A3.0-(3.0)-1200-Y-22°/67°-UV | Working distance typ. 50 mm ... 300 mm |
| KL-M34-R1.1 | R-S-R1.1-(3x0.5)-1200-22°-UV | Working distance typ. 50 mm ... 200 mm |
| | R-S-R1.1-(3x0.5)-1200-Y-22°/67°-UV | Working distance typ. 50 mm ... 200 mm |
| KL-M34-R2.1 | R-S-R2.1-(6x1)-1200-22°-UV | Working distance typ. 50 mm ... 300 mm |
| | R-S-R2.1-(6x1)-1200-Y-22°/67°-UV | Working distance typ. 50 mm ... 300 mm |
| | | |
| KL-M34-XL-A1.1 | R-S-A1.1-(1.5)-1200-22°-UV | Working distance typ. 50 mm ... 400 mm |
| | R-S-A1.1-(1.5)-1200-Y-22°/67°-UV | Working distance typ. 50 mm ... 400 mm |
| KL-M34-XL-A2.0 | R-S-A2.0-(2.5)-1200-22°-UV | Working distance typ. 50 mm ... 400 mm |
| | R-S-A2.0-(2.5)-1200-Y-22°/67°-UV | Working distance typ. 50 mm ... 400 mm |
| KL-M34-XL-A3.0 | R-S-A3.0-(3.0)-1200-22°-UV | Working distance typ. 50 mm ... 400 mm |
| | R-S-A3.0-(3.0)-1200-Y-22°/67°-UV | Working distance typ. 50 mm ... 400 mm |
| KL-M34-XL-R1.1 | R-S-R1.1-(3x0.5)-1200-22°-UV | Working distance typ. 50 mm ... 400 mm |
| | R-S-R1.1-(3x0.5)-1200-Y-22°/67°-UV | Working distance typ. 50 mm ... 400 mm |
| KL-M34-XL-R2.1 | R-S-R2.1-(6x1)-1200-22°-UV | Working distance typ. 50 mm ... 400 mm |
| | R-S-R2.1-(6x1)-1200-Y-22°/67°-UV | Working distance typ. 50 mm ... 400 mm |
| | | |
| KL-M34/62-A1.1 | R-S-A1.1-(1.5)-1200-22°-UV | Working distance typ. 80 mm ... 200 mm |
| | R-S-A1.1-(1.5)-1200-Y-22°/67°-UV | Working distance typ. 80 mm ... 200 mm |
| KL-M34/62-A2.0 | R-S-A2.0-(2.5)-1200-22°-UV | Working distance typ. 80 mm ... 200 mm |
| | R-S-A2.0-(2.5)-1200-Y-22°/67°-UV | Working distance typ. 80 mm ... 200 mm |
| KL-M34/62-A3.0 | R-S-A3.0-(3.0)-1200-22°-UV | Working distance typ. 80 mm ... 200 mm |
| | R-S-A3.0-(3.0)-1200-Y-22°/67°-UV | Working distance typ. 80 mm ... 200 mm |
| KL-M34/62-R1.1 | R-S-R1.1-(3x0.5)-1200-22°-UV | Working distance typ. 80 mm ... 200 mm |
| | R-S-R1.1-(3x0.5)-1200-Y-22°/67°-UV | Working distance typ. 80 mm ... 200 mm |
| KL-M34/62-R2.1 | R-S-R2.1-(6x1)-1200-22°-UV | Working distance typ. 80 mm ... 200 mm |
| | R-S-R2.1-(6x1)-1200-Y-22°/67°-UV | Working distance typ. 80 mm ... 200 mm |



Optical frontends for UV fiber optics in Y-shape (22°/67°/67°-UV, for use with an external UV light source):

| Part number: | Suitable for fiber optics type: (R = reflected light) | Characteristics: |
|----------------|--|-------------------------------------|
| KL-3 | R-S-A2.0-(2.5)-...-Y-22°/67°/67°-UV | Working range typ. 10 mm ... 20 mm |
| KL-4 | R-S-A1.1-(1.5)-...-Y-22°/67°/67°-UV | Working range typ. 10 mm ... 15 mm |
| KL-5 | R-S-R1.1-(3x0.5)-...-Y-22°/67°/67°-UV | Working range typ. 8 mm ... 20 mm |
| KL-8 | R-S-R2.1-(6x1)-...-Y-22°/67°/67°-UV | Working range typ. 8 mm ... 25 mm |
| KL-9 | R-S-A3.0-(3.0)-...-Y-22°/67°/67°-UV | Working range typ. 8 mm ... 25 mm |
| KL-M8-A1.1 | R-S-A1.1-(1.5)-...-Y-22°/67°/67°-UV | Working range typ. 8 mm ... 20 mm |
| KL-M12-A1.1 | R-S-A1.1-(1.5)-...-Y-22°/67°/67°-UV | Working range typ. 8 mm ... 20 mm |
| KL-M12-A2.0 | R-S-A2.0-(2.0)-...-Y-22°/67°/67°-UV | Working range typ. 8 mm ... 20 mm |
| KL-M12-A3.0 | R-S-A3.0-(3.0)-...-Y-22°/67°/67°-UV | Working range typ. 8 mm ... 20 mm |
| KL-M12-R1.1 | R-S-R1.1-(3x0.5)-...-Y-22°/67°/67°-UV | Working range typ. 8 mm ... 20 mm |
| KL-M12-XL-A1.1 | R-S-A1.1-(1.5)-...-Y-22°/67°/67°-UV | Working range typ. 30 mm ... 200 mm |
| KL-M12-XL-A2.0 | R-S-A2.0-(2.5)-...-Y-22°/67°/67°-UV | Working range typ. 30 mm ... 200 mm |
| KL-M12-XL-R1.1 | R-S-R1.1-(3x0.5)-...-Y-22°/67°/67°-UV | Working range typ. 30 mm ... 200 mm |
| KL-M18-A1.1 | R-S-A1.1-(1.5)-...-Y-22°/67°/67°-UV | Working range typ. 10 mm ... 60 mm |
| KL-M18-A2.0 | R-S-A2.0-(2.5)-...-Y-22°/67°/67°-UV | Working range typ. 10 mm ... 80 mm |
| KL-M18-A3.0 | R-S-A3.0-(3.0)-...-Y-22°/67°/67°-UV | Working range typ. 10 mm ... 80 mm |
| KL-M18-R1.1 | R-S-R1.1-(3x0.5)-...-Y-22°/67°/67°-UV | Working range typ. 10 mm ... 60 mm |
| KL-M18-R2.1 | R-S-R2.1-(6x1)-...-Y-22°/67°/67°-UV | Working range typ. 10 mm ... 80 mm |
| KL-M18-XL-A1.1 | R-S-A1.1-(1.5)-...-Y-22°/67°/67°-UV | Working range typ. 50 mm ... 300 mm |
| KL-M18-XL-A2.0 | R-S-A2.0-(2.5)-...-Y-22°/67°/67°-UV | Working range typ. 50 mm ... 300 mm |
| KL-M18-XL-A3.0 | R-S-A3.0-(3.0)-...-Y-22°/67°/67°-UV | Working range typ. 50 mm ... 300 mm |
| KL-M18-XL-R1.1 | R-S-R1.1-(3x0.5)-...-Y-22°/67°/67°-UV | Working range typ. 50 mm ... 300 mm |
| KL-M18-XL-R2.1 | R-S-R2.1-(6x1)-...-Y-22°/67°/67°-UV | Working range typ. 50 mm ... 300 mm |
| KL-M34-A1.1 | R-S-A1.1-(1.5)-...-Y-22°/67°/67°-UV | Working range typ. 50 mm ... 200 mm |
| KL-M34-A2.0 | R-S-A2.0-(2.5)-...-Y-22°/67°/67°-UV | Working range typ. 50 mm ... 250 mm |
| KL-M34-A3.0 | R-S-A3.0-(3.0)-...-Y-22°/67°/67°-UV | Working range typ. 50 mm ... 300 mm |
| KL-M34-R1.1 | R-S-R1.1-(3x0.5)-...-Y-22°/67°/67°-UV | Working range typ. 50 mm ... 200 mm |
| KL-M34-R2.1 | R-S-R2.1-(6x1)-...-Y-22°/67°/67°-UV | Working range typ. 50 mm ... 300 mm |
| KL-M34/62-A1.1 | R-S-A1.1-(1.5)-...-Y-22°/67°/67°-UV | Working range typ. 80 mm ... 200 mm |
| KL-M34/62-A2.0 | R-S-A2.0-(2.5)-...-Y-22°/67°/67°-UV | Working range typ. 80 mm ... 200 mm |
| KL-M34/62-A3.0 | R-S-A3.0-(3.0)-...-Y-22°/67°/67°-UV | Working range typ. 80 mm ... 200 mm |
| KL-M34/62-R1.1 | R-S-R1.1-(3x0.5)-...-Y-22°/67°/67°-UV | Working range typ. 80 mm ... 200 mm |
| KL-M34/62-R2.1 | R-S-R2.1-(6x1)-...-Y-22°/67°/67°-UV | Working range typ. 80 mm ... 200 mm |



KL-1

Focus lens KL-1

Suitable for fiber optics with transmitted light operation

D-S-A2.0-(2.5)-...-67° or

D-S-A2.0-(2.5)-...-22°

(for transmitted light fiber optics 2 pcs. KL-1 are necessary)

Characteristics:

- Transmitter/receiver distance yp. 50 mm ... 200 mm
- Focusing onto a small light spot
- Enlargement of range
- Better illumination
- Scratch-resistant optics made of glass
- Sturdy aluminum housing, anodized in black

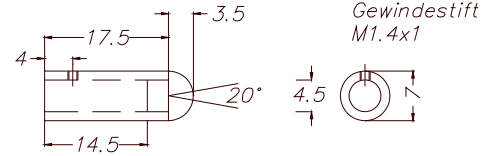
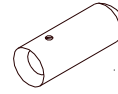

All dimensions in mm



KL-2

Focus lens KL-2

Suitable for fiber optics with reflected light operation

R-S-A2.0-(2.5)-...-67° or

R-S-A2.0-(2.5)-...-22°

(for reflected light fiber optics 1 pc. KL-2 is necessary)

Suitable for fiber optics with transmitted light operation

D-S-A2.0-(2.5)-...-67° or

D-S-A2.0-(2.5)-...-22°

(for transmitted light fiber optics 2 pcs. KL-2 are necessary)

Characteristics:

- Beam divergency $\pm 7.5^\circ$
- Transmitter/receiver distance max. 300 mm
- Focusing onto a small light spot
- Enlargement of range
- Better illumination
- Scratch-resistant optics made of glass
- Sturdy aluminum housing, anodized in black

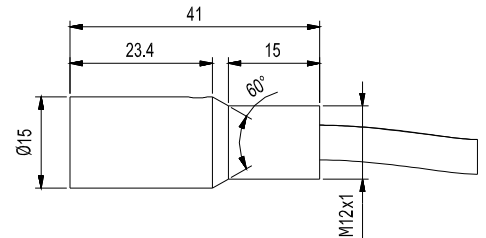

All dimensions in mm



KL-3

Focus lens KL-3

Suitable for fiber optics with reflected light operation

R-S-A2.0-(2.5)-...-67° oder

R-S-A2.0-(2.5)-...-22°

(for reflected light fiber optics 1 pc. KL-3 is necessary)

Characteristics:

- Focusing onto a small light spot (spot diameter at a distance of 10 mm: typ. 1 mm)
- Working distance typ. 10 mm ... 20 mm
- Color measurement of small objects at a relatively big distance
- Scratch-resistant optics made of glass
- Sturdy aluminum housing, anodized in black

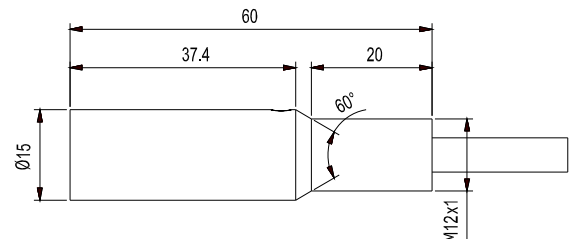

All dimensions in mm



KL-3/30

Transmitted light optics KL-3/30:

**Suitable for fiber optics with reflected/transmitted light operation
R/D-S-A2.0-(2.5/1.75)-1200-67°**

Characteristics:

- Suitable for detection of fluids (transported e.g. in display glasses) in reflected or transmitted light operation, for example when spray liquid is led to spray facilities
- Minimum change of color when distance changes
- Working distance typ. 30 mm
- Can be focused
- Scratch-resistant optics made of glass
- Sturdy aluminum housing

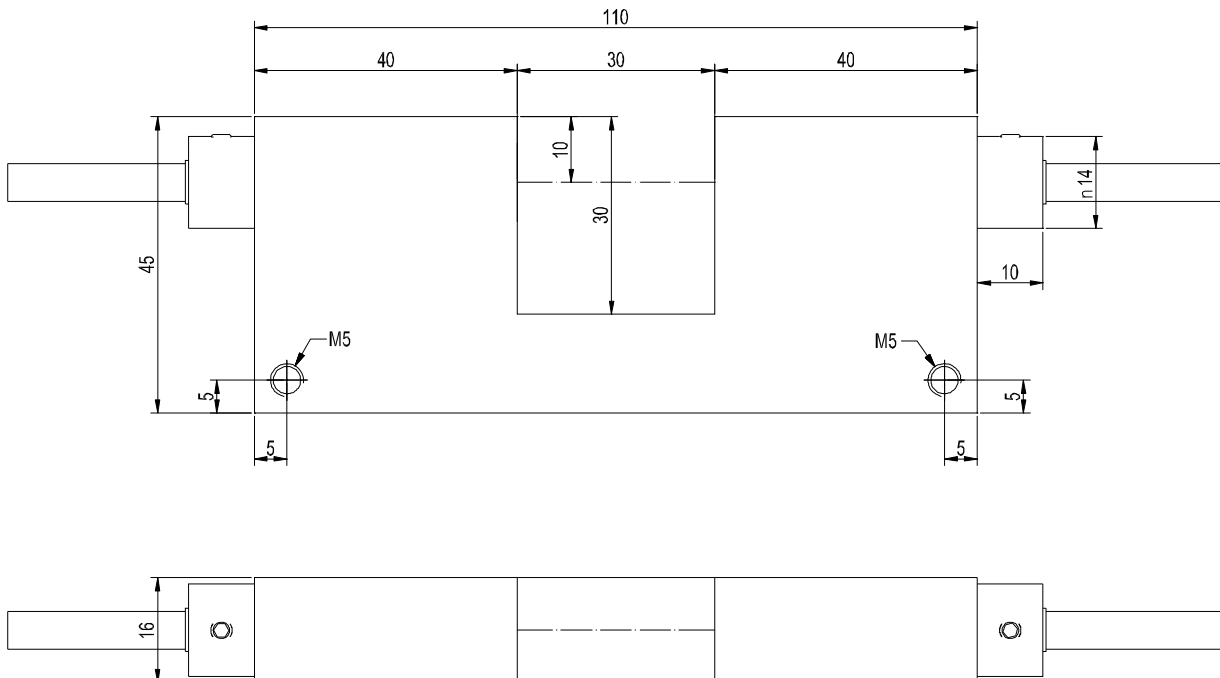
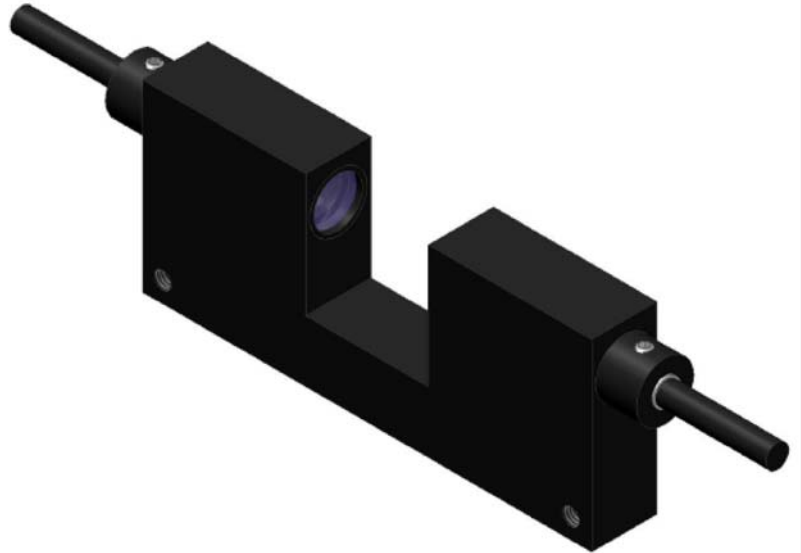

All dimensions in mm



KL-4

Focus lens KL-4

Suitable for fiber optics with reflected light operation

R-S-A1.1-(0.6)-...-67° or

R-S-A1.1-(0.6)-...-22° or

R-S-A1.1-(1.1)-...-67° or

R-S-A1.1-(1.1)-...-22° or

R-S-A1.1-(1.5)-...-67° or

R-S-A1.1-(1.5)-...-22°

(for reflected light fiber optics 1 pc. KL-4 is necessary)



All dimensions in mm

Characteristics:

- Focusing onto a small light spot (spot diameter at 10 mm distance: typ. 0.5 mm)
- Working distance typ. 10 mm ... 15 mm
- Color measurement at small objects in relatively big distance
- Scratch-resistant optics made of glass
- Sturdy aluminum housing, anodized in black

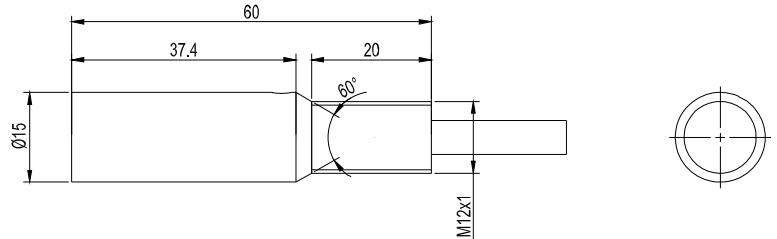

KL-5

Focus lens KL-5

Suitable for fiber optics with reflected light operation

R-S-R1.1-(3x0.5)-...-67° or

R-S-R1.1-(3x0.5)-...-22°

(for reflected light fiber optics 1 pc. KL-5 is necessary)



All dimensions in mm

Characteristics:

- Focusing onto a small light spot (spot size at 10 mm distance: typ. 2 mm x 0.2 mm)
- Working distance typ. 8 mm ... 20 mm
- Color measurement at small objects in relatively big distance
- Scratch-resistant optics made of glass
- Sturdy aluminum housing, anodized in black

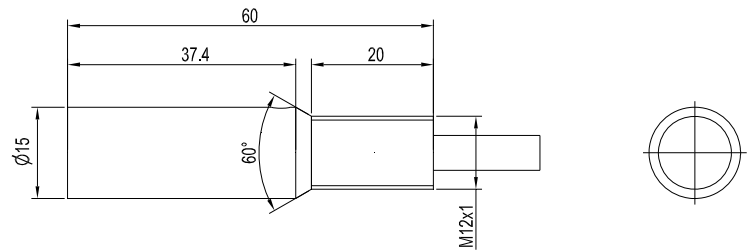



KL-8

Focus lens KL-8

Suitable for fiber optics with reflected light operation
 R-S-R2.1-(6x1)-...-67° or
 R-S-R2.1-(6x1)-...-22°
 (for reflected light fiber optics 1 pc. KL-8 is necessary)

Characteristics:

- Focusing onto a small light spot
 (spot size at 11 mm distance: typ. 4 mm x 1.5 mm)
- Working distance typ. 8 mm ... 25 mm
- Color measurement at small objects in relatively big distance
- Scratch-resistant optics made of glass
- Sturdy aluminum housing, anodized in black



All dimensions in mm

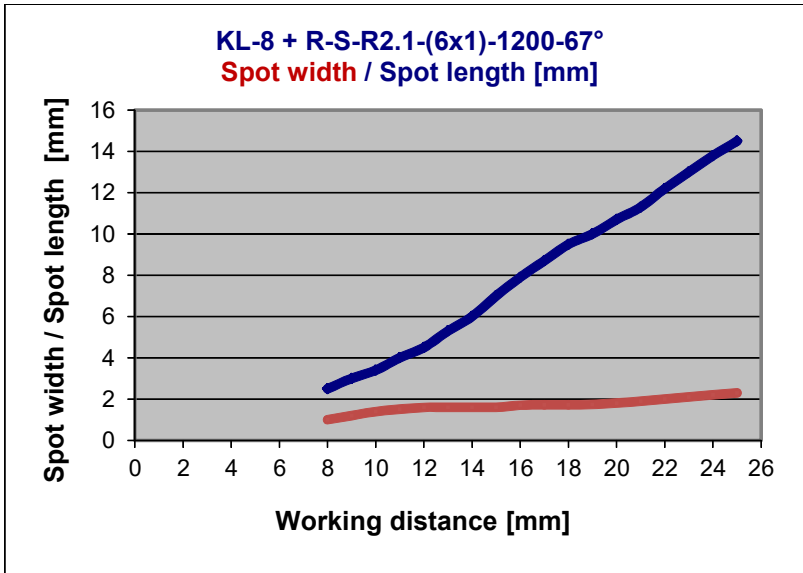
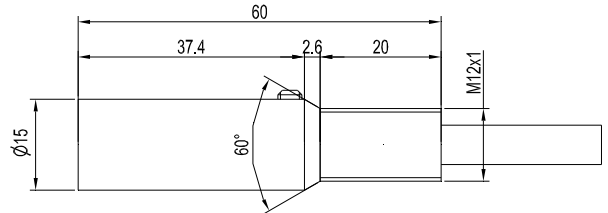

KL-8 with R-S-R2.1-(6x1)-1200-67°:

Spot sizes:

- 2.5 mm x 1 mm (typ.) at working distance 8 mm
- 4 mm x 1.5 mm (typ.) at working distance 11 mm
- 8 mm x 1.7 mm (typ.) at working distance 16 mm
- 10.5 mm x 1.8 mm (typ.) at working distance 20 mm
- 14.5 mm x 2.3 mm (typ.) at working distance 25 mm



KL-8-N

Focus lens KL-8-N

Suitable for fiber optics with reflected light operation
 R-S-R2.1-(6x1)-...-67° or
 R-S-R2.1-(6x1)-...-22°
 (for reflected light fiber optics 1 pc. KL-8-N is necessary)

Characteristics:

- With guide slot (adjustment aid)
- Focusing onto a small light spot (spot size at 10 mm distance: typ. 4 mm x 0.5 mm)
- Working distance typ. 8 mm ... 25 mm
- Color measurement at small objects in relatively big distance
- Scratch-resistant optics made of glass
- Sturdy aluminum housing, anodized in black

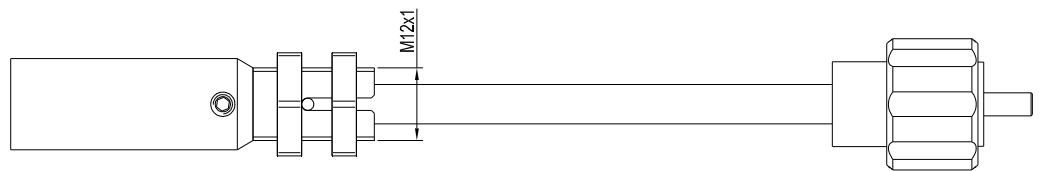
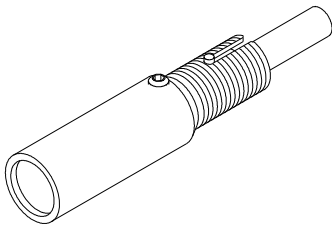
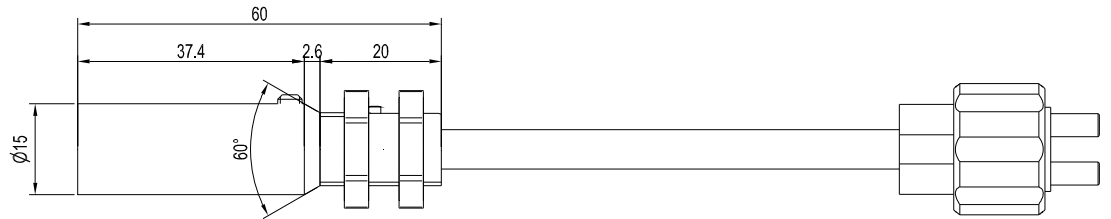

All dimensions in mm



KL-9

Focus lens KL-9

Suitable for fiber optics with reflected light operation
 R-S-A3.0-(3.0)-...-67° or
 R-S-A3.0-(3.0)-...-22°
 (for reflected light fiber optics 1 pc. KL-9 is necessary)

Characteristics:

- Focusing onto a small light spot (spot diameter at 10 mm distance: typ. 0.5 mm)
- Working distance typ. 8 mm ... 25 mm
- Color measurement at small objects in relatively big distance
- Scratch-resistant optics made of glass
- Sturdy aluminum housing, anodized in black

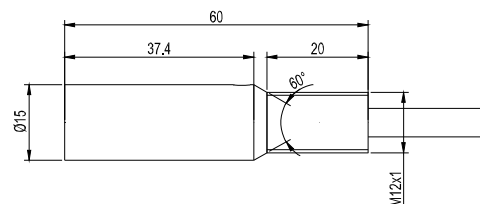

All dimensions in mm



KL-90

Prismatic optics KL-90

Suitable for fiber optics with transmitted light operation
D-S-A2.0-(2.5)-...-67° or
D-S-A2.0-(2.5)-...-22°
 (for transmitted light fiber optics 2 pcs. KL-90 are necessary)

Characteristics:

- Working distance: typ. 20 mm ... 100 mm
- Can be focused
- High luminous efficacy
- Scratch-resistant optics made of glass
- Low mounting depth
- Sturdy aluminum housing, anodized in black

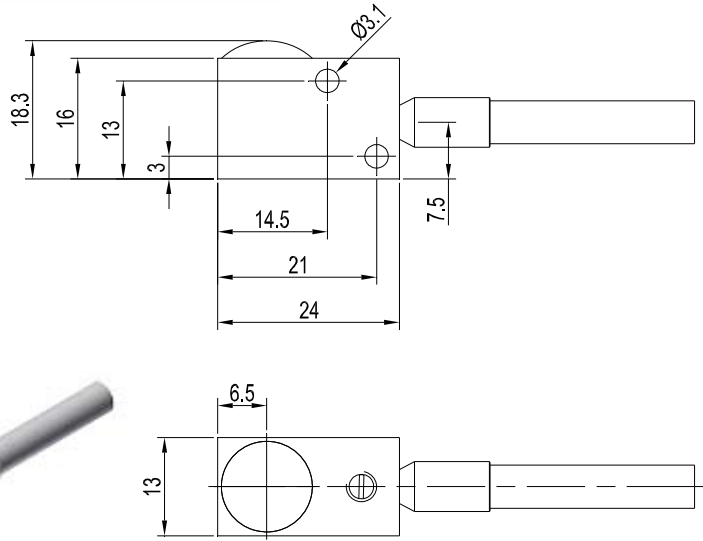

All dimensions in mm

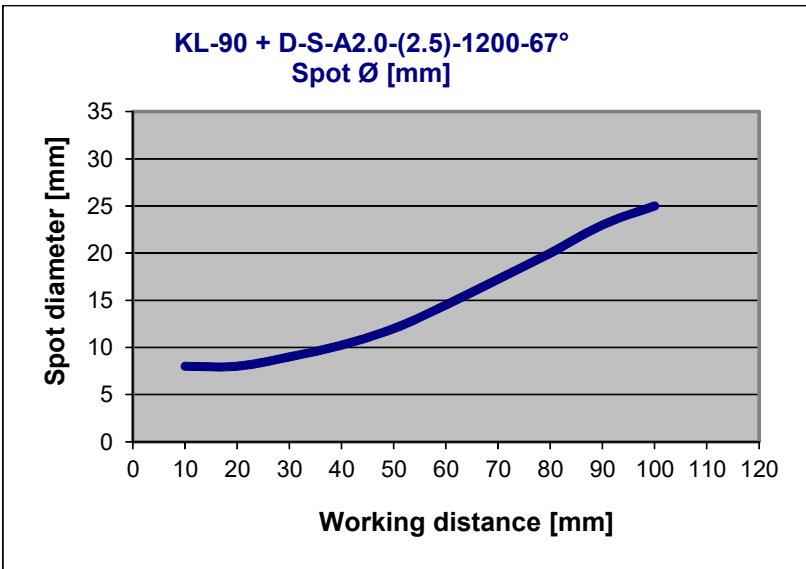

KL-90 with D-S-A2.0-(2.5)-1200-67°:

Spot diameter:

- 8 mm (typ.) at working distance 10 mm
- 12 mm (typ.) at working distance 50 mm
- 25 mm (typ.) at working distance 100 mm

Max. distance transmitter/receiver = 400 mm
 in case of optical transparent (bright) objects.

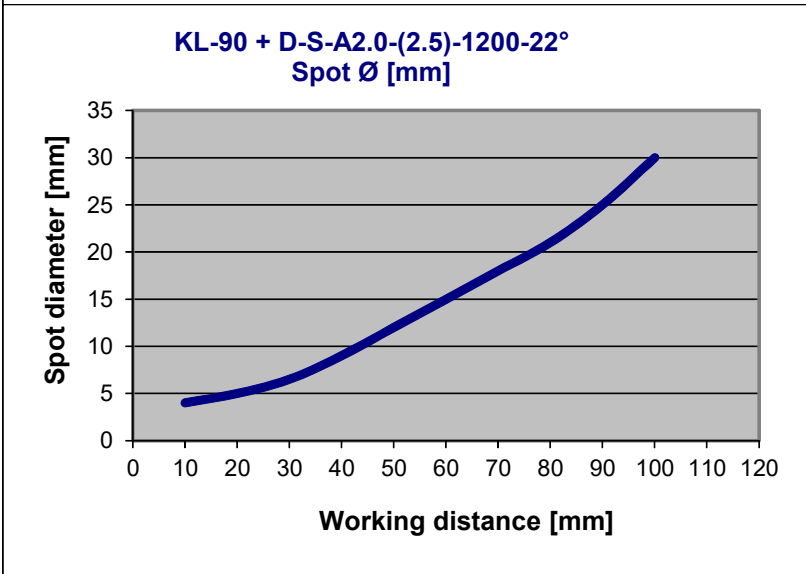

KL-90 with D-S-A2.0-(2.5)-1200-22°:

Spot diameter:

- 4 mm (typ.) at working distance 10 mm
- 13 mm (typ.) at working distance 50 mm
- 30 mm (typ.) at working distance 100 mm

Max. distance transmitter/receiver = 400 mm
 in case of optical transparent (bright) objects.





KL-D-2.5

Reflection optics KL-D-2.5

All dimensions in mm

**Suitable for fiber optics with transmitted light operation
D-S-A2.0-(2.5)-...-67°**

Characteristics:

- Also suitable for detection of highly absorbing objects (e.g. black varnished parts)
- Working range typ. 100 mm ... 500 mm
- Minimal color change when changing the distance
- Can be focused
- Scratch-resistant optics made of glass
- Sturdy aluminum housing, anodized in black

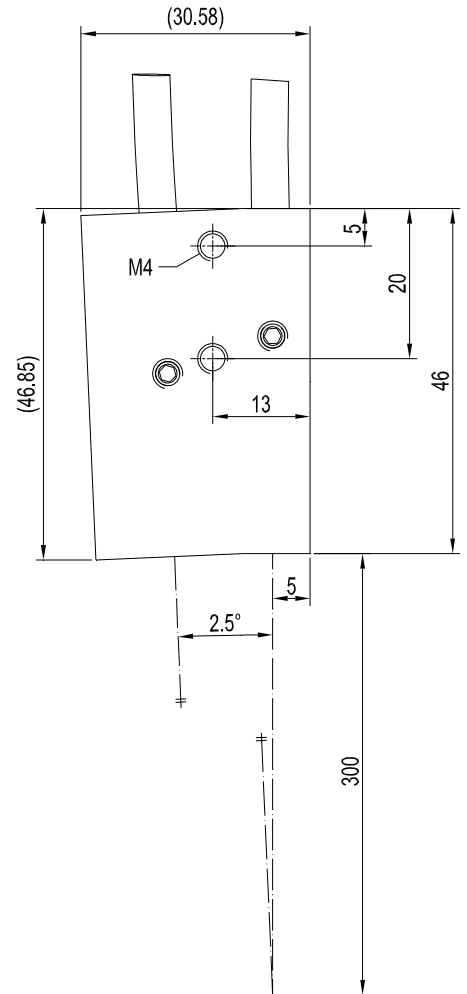
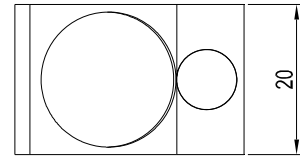

KL-D-2.5 with D-S-A2.0-(2.5)-1200-67°:

Spot diameter:
 14 mm (typ.) at working distance 100 mm
 46 mm (typ.) at working distance 300 mm
 78 mm (typ.) at working distance 500 mm

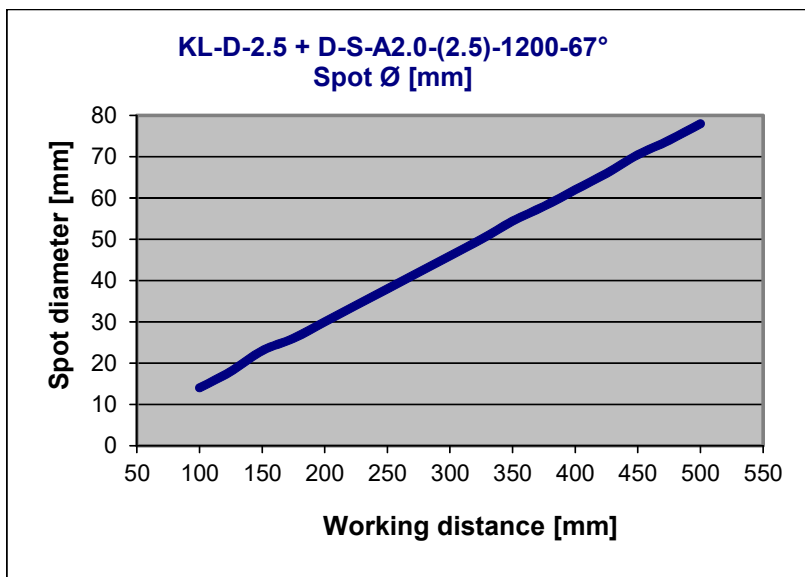



KL-D-6

Reflection optics KL-D-6

**Suitable for fiber optics with transmitted light operation
D-S-A2.0-(2.5)-...-67°**

Characteristics:

- Suitable also for detection of highly absorbing objects (e.g. black varnished parts)
- Working distance typ. 100 mm ... 230 mm
- Minimal color change when changing the distance
- Can be focused
- Scratch-resistant optics made of glass
- Sturdy aluminum housing, anodized in black

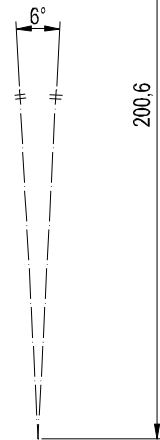
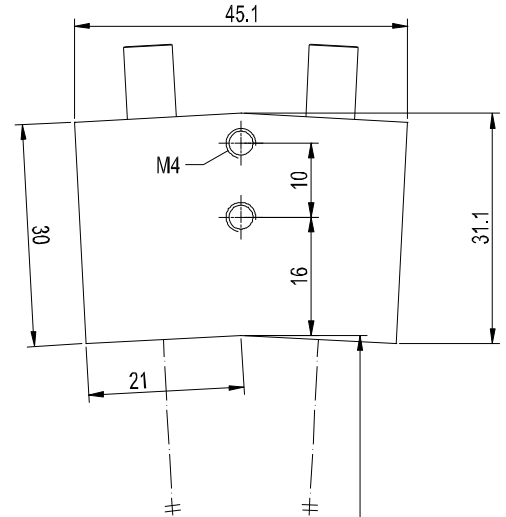
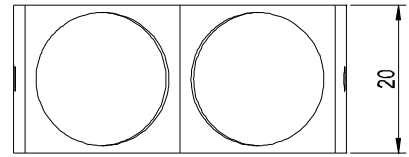

All dimensions in mm

KL-D-6 with D-S-A2.0-(2.5)-1200-67°:

Spot diameter:
 15 mm (typ.) at working distance 100 mm
 24 mm (typ.) at working distance 160 mm
 36 mm (typ.) at working distance 230 mm

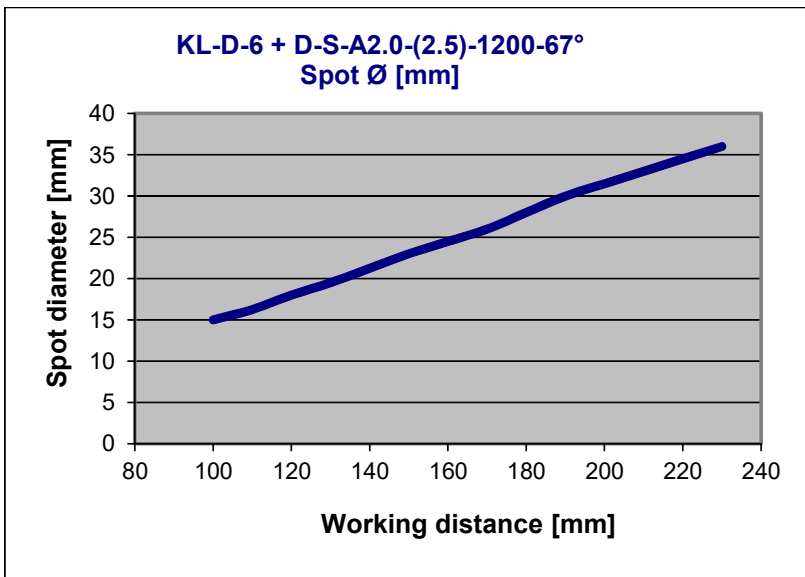



KL-D-14

Reflection optics KL-D-14

**Suitable for fiber optics with transmitted light operation
D-S-A2.0-(2.5)-...-67°**

Characteristics:

- Suitable also for detection of highly absorbing objects (e.g. black varnished parts)
- Working distance typ. 60 mm ... 120 mm
- Minimal color change when changing the distance
- Can be focused
- Scratch-resistant optics made of glass
- Sturdy aluminum housing, anodized in black

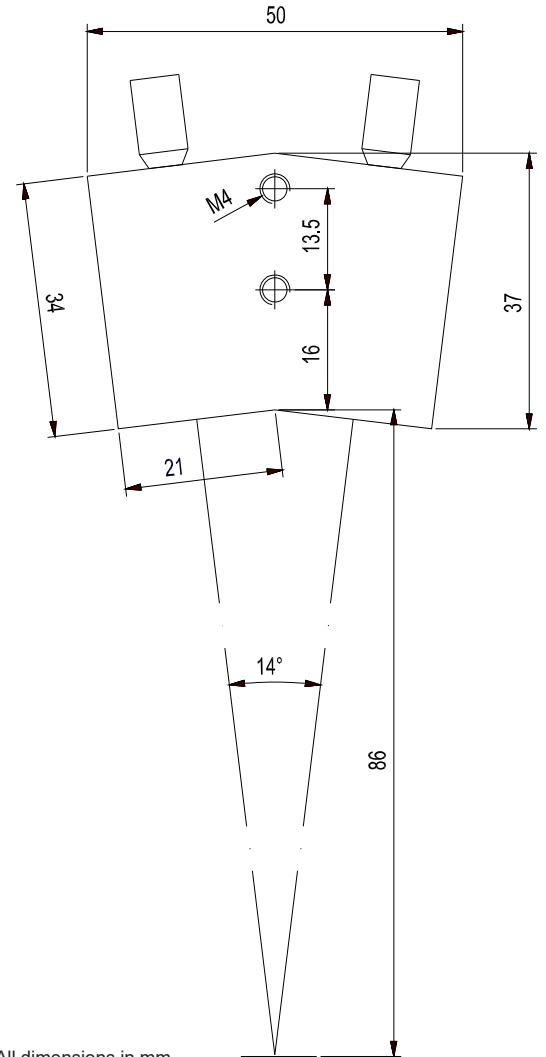
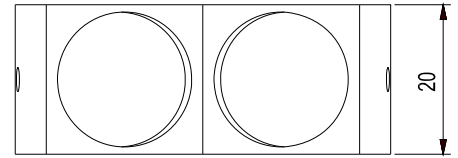

All dimensions in mm

KL-D-14 with D-S-A2.0-(2.5)-1200-67°:

Spot diameter:
 9 mm (typ.) at working distance 60 mm
 13 mm (typ.) at working distance 90 mm
 18 mm (typ.) at working distance 120 mm

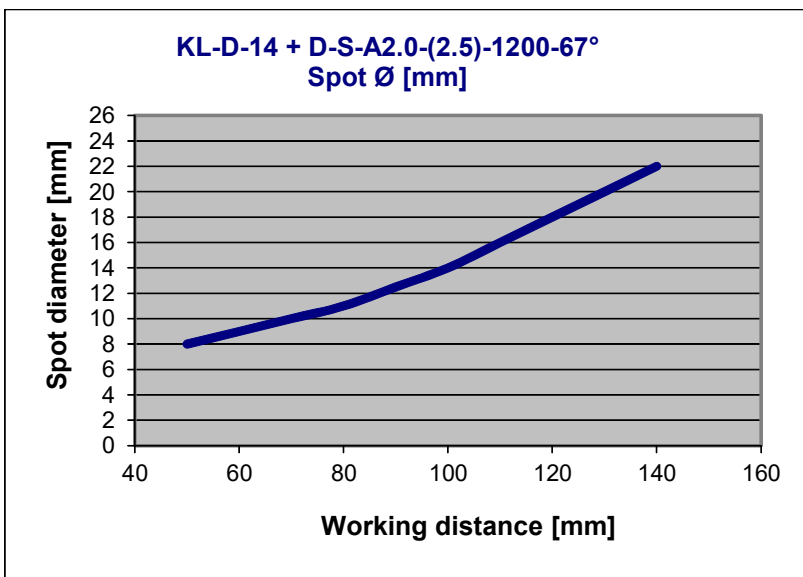



KL-D-14-T400

**Reflection optics KL-D-14-T400
(high-temperature resistant)**

**Suitable for fiber optics with transmitted light operation
D-S-A2.0-(2.5)-...-67°-T400**

Characteristics:

- Suitable also for detection of highly absorbing objects (e.g. black varnished parts)
- Working distance typ. 60 mm ... 120 mm
- Minimal color change when changing the distance
- Can be focused
- Scratch-resistant optics made of glass
- Sturdy aluminum housing, anodized in black
- Thermally stable up to 400°C

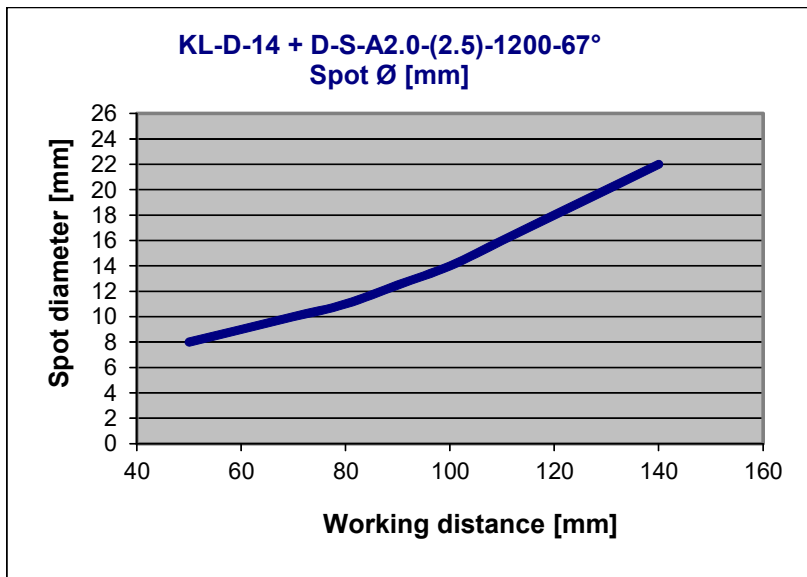
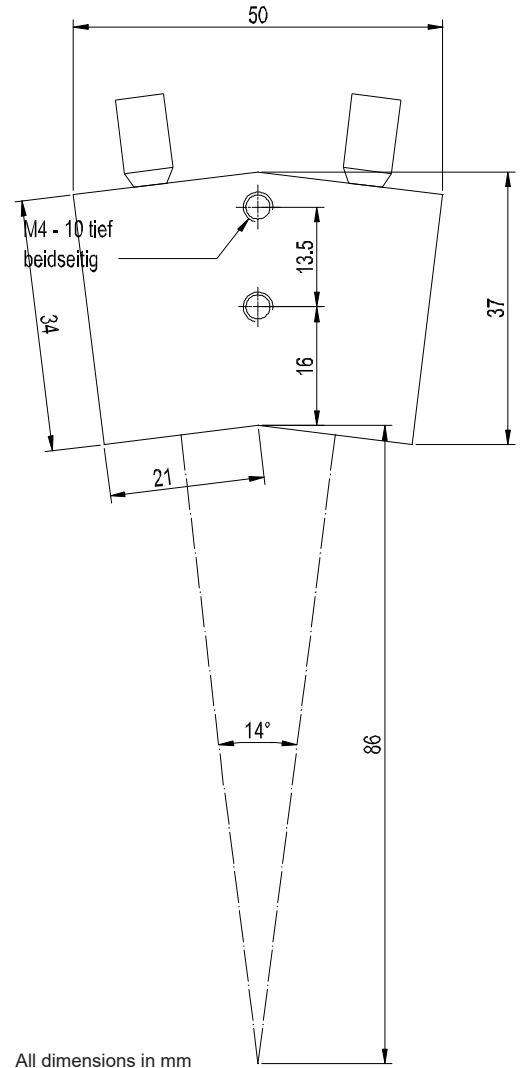
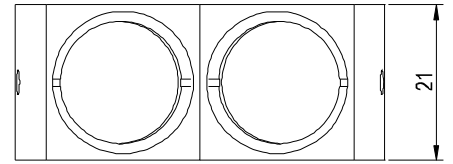

KL-D-14 with D-S-A2.0-(2.5)-1200-67°:

Spot diameter:
9 mm (typ.) at working distance 60 mm
13 mm (typ.) at working distance 90 mm
18 mm (typ.) at working distance 120 mm



KL-D-17

Reflection optics KL-D-17

**Suitable for fiber optics with transmitted light operation
D-S-A2.0-(2.5)-...-67°**

Characteristics:

- Suitable also for detection of highly absorbing objects (e.g. black varnished parts)
- Working distance typ. 30 mm ... 80 mm
- Minimal color change when changing the distance
- Can be focused
- Scratch-resistant optics made of glass
- Sturdy aluminum housing, anodized in black

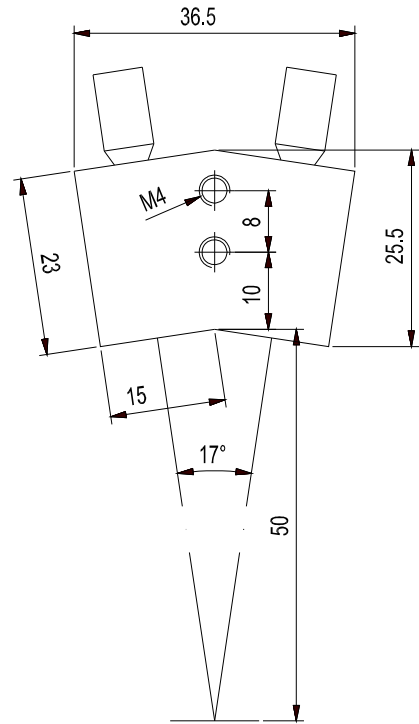
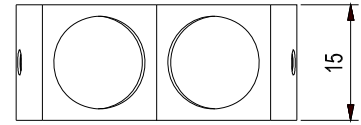

All dimensions in mm

KL-D-17 with D-S-A2.0-(2.5)-1200-67°:

Spot diameter:

- 8 mm (typ.) at working distance 30 mm
- 15 mm (typ.) at working distance 55 mm
- 23 mm (typ.) at working distance 80 mm

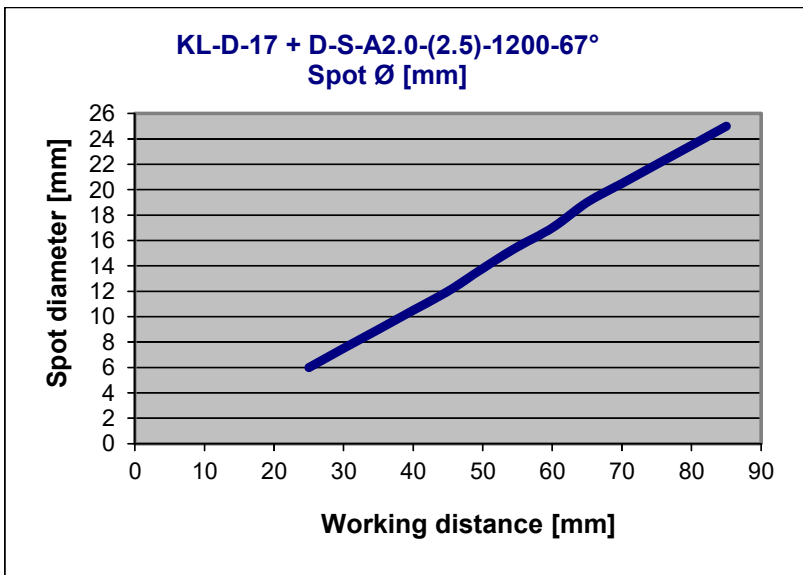



KL-D-20

Reflection optics KL-D-20:

Suitable for fiber optics with transmitted light operation
D-S-A2.0-(2.5)-...-67°

Characteristics:

- Working distance typ. 10 mm ... 50 mm
- Minimal color change when changing the distance
- Can be focused
- Scratch-resistant optics made of glass
- Sturdy aluminum housing, anodized in black

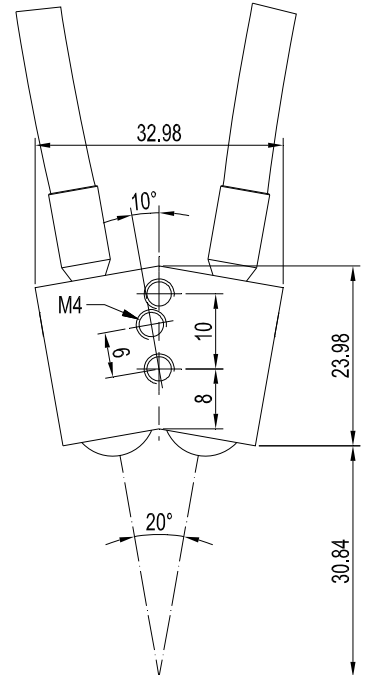
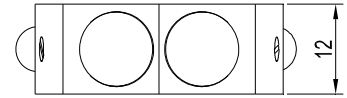

All dimensions in mm

KL-D-20 with D-S-A2.0-(2.5)-1200-67°:

Spot diameter:
 5 mm (typ.) at working distance 20 mm
 7 mm (typ.) at working distance 30 mm
 10 mm (typ.) at working distance 40 mm

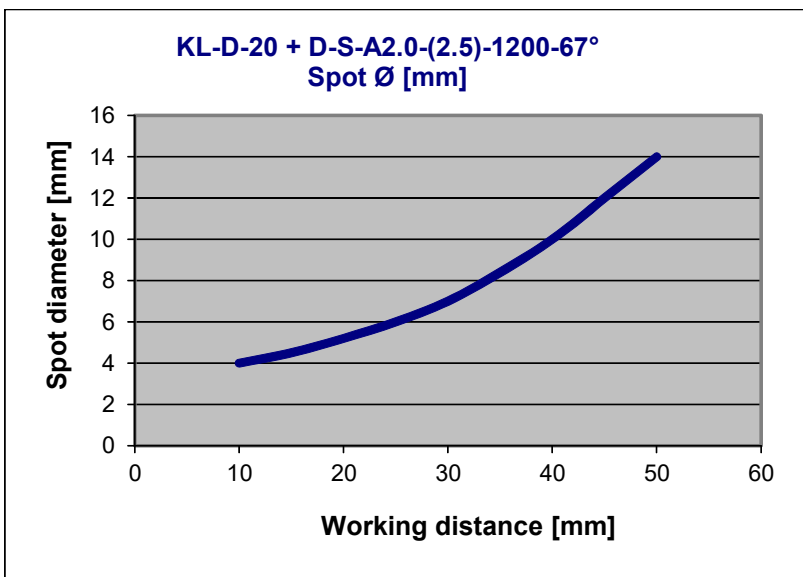



KL-D-28

Reflection optics KL-D-28

Suitable for fiber optics with transmitted light operation
D-S-A2.0-(2.5)-...-67°

- Suitable also for detection of highly absorbing objects (e.g. black varnished parts)
- Working range typ. 20 mm ... 50 mm
- Minimal color change when changing the distance
- Can be focused
- Scratch-resistant optics made of glass
- Sturdy aluminum housing, anodized in black

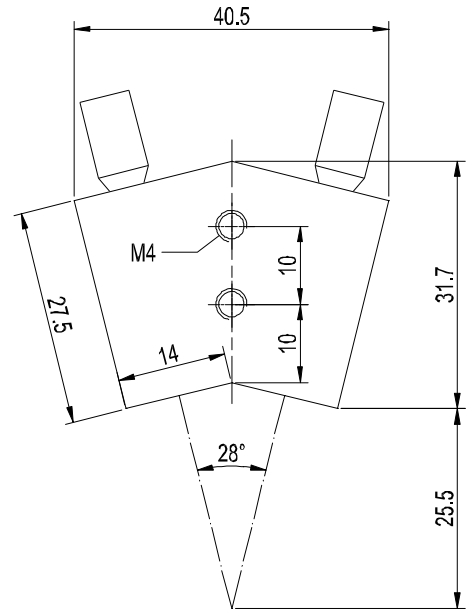
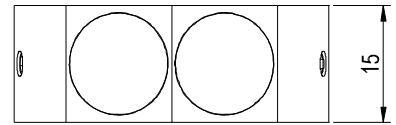

Alle Abmessungen in mm

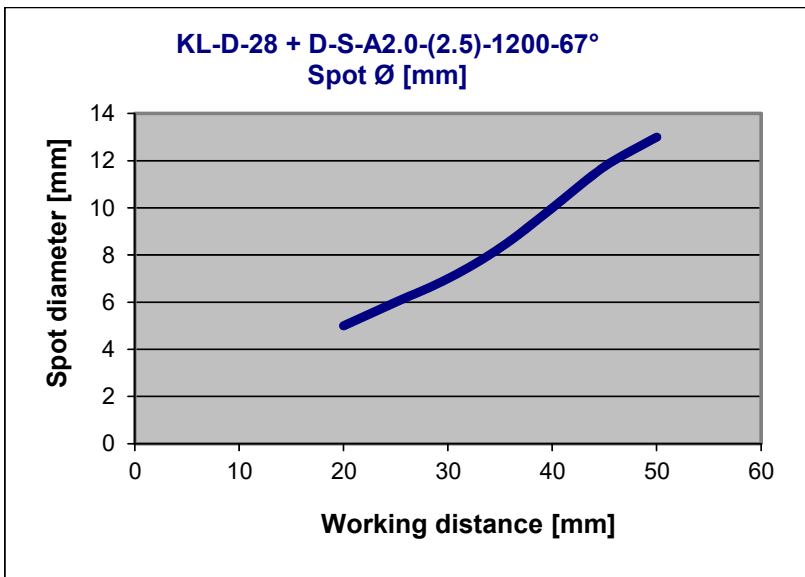

KL-D-28 with D-S-A2.0-(2.5)-1200-67°:

Spot diameter:
 5 mm (typ.) at working distance 20 mm
 8 mm (typ.) at working distance 35 mm
 13 mm (typ.) at working distance 50 mm





KL-D-30

Reflection optics KL-D-30

**Suitable for fiber optics with transmitted light operation
D-S-A2.0-(2.5)-...-67°**

Characteristics:

- Suitable also for detection of highly absorbing objects (e.g. black varnished parts)
- Working range typ. 20 mm ... 30 mm
- Minimal color change when changing the distance
- Can be focused
- Scratch-resistant optics made of glass
- Sturdy aluminum housing, anodized in black

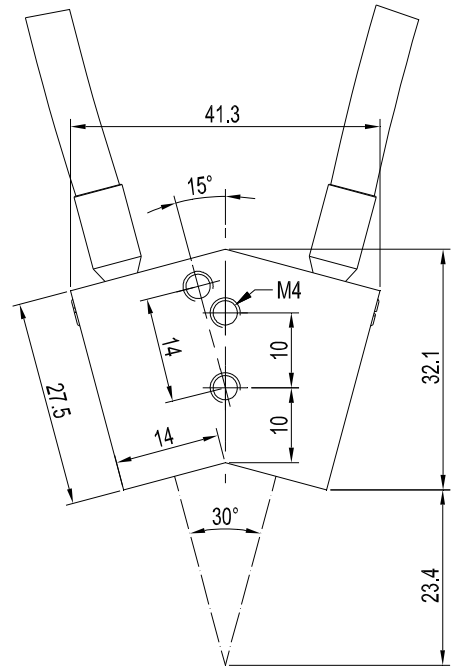
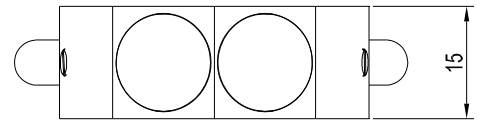

All dimensions in mm



KL-D-40

Reflection optics KL-D-40

**Suitable for fiber optics with transmitted light operation
D-S-A2.0-(2.5)-...-67°**

Characteristics:

- Suitable also for detection of highly absorbing objects (e.g. black varnished parts)
- Working distance typ. 15 mm ... 25 mm
- Minimal color change when changing the distance
- Can be focused
- Scratch-resistant optics made of glass
- Sturdy aluminum housing, anodized in black

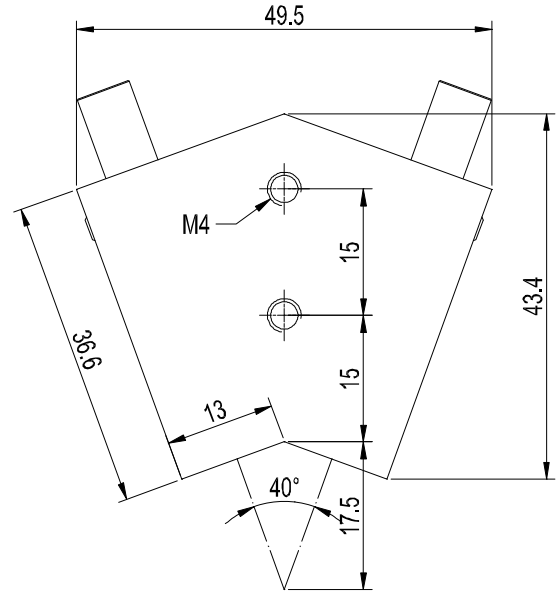
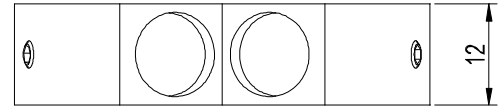

All dimensions in mm

KL-D-40 with D-S-A2.0-(2.5)-1200-67°:

Spot diameter:

- 1.5 mm (typ.) at working distance 15 mm
- 3 mm (typ.) at working distance 20 mm
- 5 mm (typ.) at working distance 25 mm

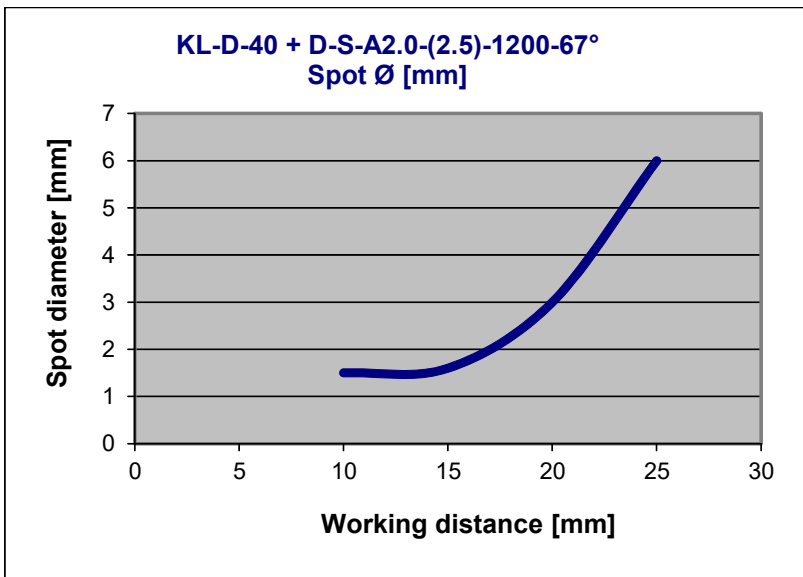



KL-M8-...

Reflection optics
KL-M8-A1.1

Suitable for fiber optics
R-S-A1.1-(0.6)-(length)-67° or
R-S-A1.1-(1.0)-(length)-67° or
R-S-A1.1-(1.5)-(length)-67°

Characteristics:

- Suitable also for detection of highly absorbing objects (e.g. black varnished parts)
- Working distance typ. 8 mm ... 20 mm
- Minimal color change when changing the distance
- Can be focused
- Scratch-resistant optics made of glass
- Sturdy aluminum housing, anodized in black



All dimensions in mm

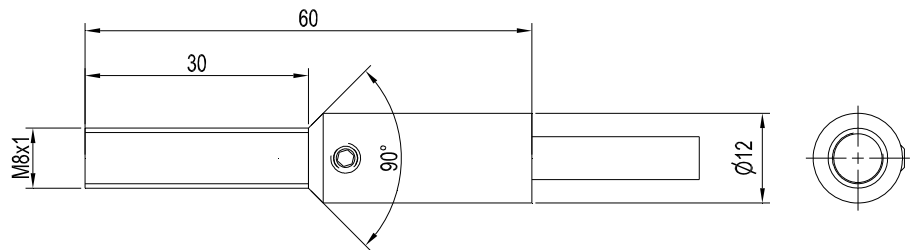



KL-M12-...

Reflection optics
KL-M12-A1.1

Suitable for fiber optics
R-S-A1.1-(0.6)-(length)-67° or
R-S-A1.1-(1.0)-(length)-67° or
R-S-A1.1-(1.5)-(length)-67°
R-S-A2.0-(2.5)-(length)-67°
R-S-A3.0-(3.0)-(length)-67°
R-S-R1.1-(3x0.5)-(length)-67°

KL-M12-A2.0
KL-M12-A3.0
KL-M12-R1.1



Characteristics:

- Suitable also for detection of highly absorbing objects (e.g. black varnished parts)
- Working distance typ. 8 mm ... 40 mm
- Minimal color change when changing the distance
- Can be focused
- Scratch-resistant optics made of glass
- Sturdy aluminum housing, anodized in black

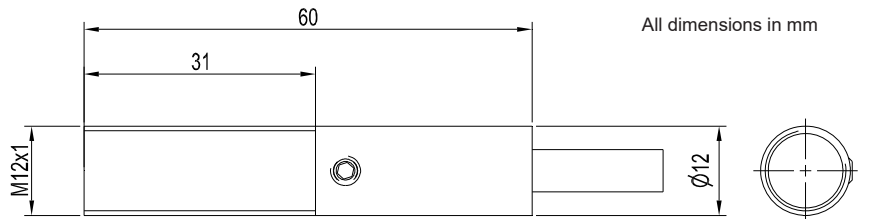

**KL-M12-A2.0 (focused to 35 mm)
+ R-S-A2.0-(2.5)-600-67°
Spot Ø [mm]**

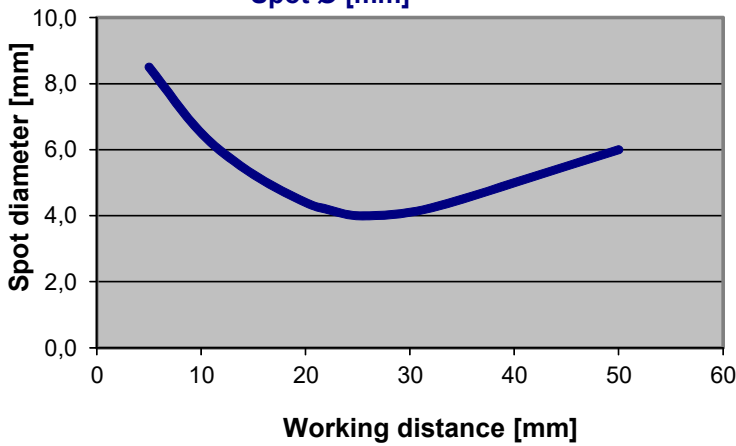

**KL-M12-A2.0 with R-S-A2.0-(2.5)-600-67°:
(focused to a distance of 35 mm):**

Spot diameter:
8.5 mm (typ.) at working distance 5 mm
4 mm (typ.) at working distance 25 mm
5 mm (typ.) at working distance 40 mm

**KL-M12-A2.0 (focused to 35 mm)
+ R-S-A2.0-(2.5)-600-67°
INT [relative]**

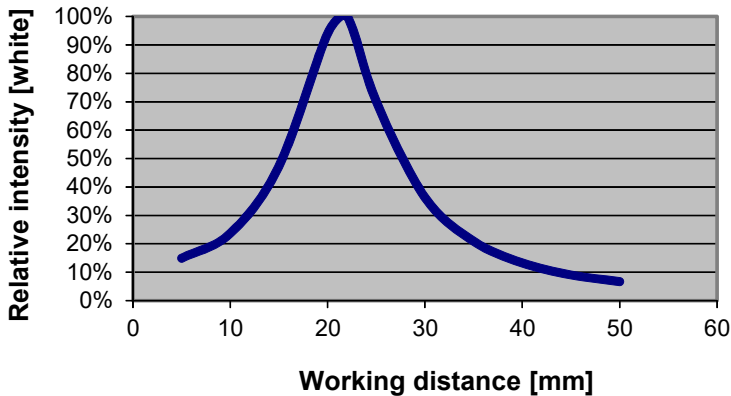

**KL-M12-A2.0 with R-S-A2.0-(2.5)-600-67°:
(focused to a distance of 35 mm):**

Relative intensity:
100% at working distance 22 mm
(INTENSITY 3791)





KL-M12-XL-...

Reflection optics
KL-M12-XL-A1.1

Suitable for fiber optics
R-S-A1.1-(0.6)-(length)-67° or
R-S-A1.1-(1.0)-(length)-67° or
R-S-A1.1-(1.5)-(length)-67°
R-S-A2.0-(2.5)-(length)-67°
R-S-R1.1-(3x0.5)-(length)-67°
D-S-A2.0-(2.5)-(length)-67°

KL-M12-XL-A2.0
KL-M12-XL-R1.1
KL-M12-XL-30°/30-A2.0

Characteristics:

- Suitable also for detection of highly absorbing objects (e.g. black varnished parts)
- Working distance typ. 10 mm ... 100 mm
- Minimal color change when changing the distance
- Can be focused
- Scratch-resistant optics made of glass
- Sturdy aluminum housing, anodized in black



KL-M12-XL-A1.1
KL-M12-XL-A2.0
KL-M12-XL-R1.1

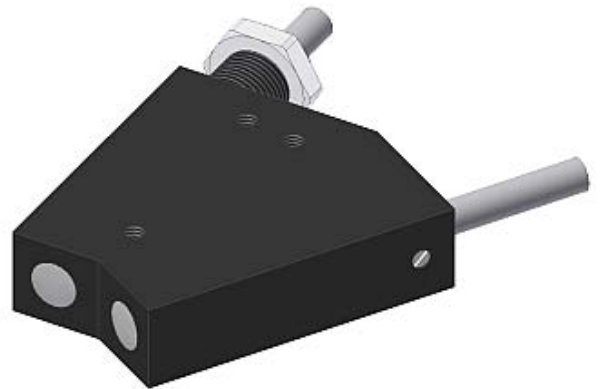

KL-M12-XL-30°/30-A2.0

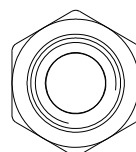
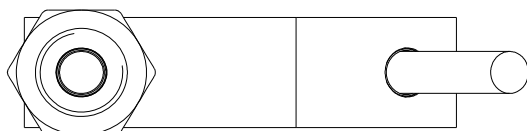
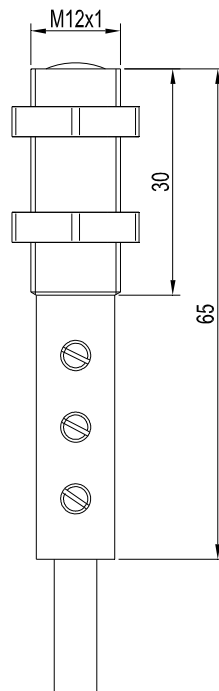
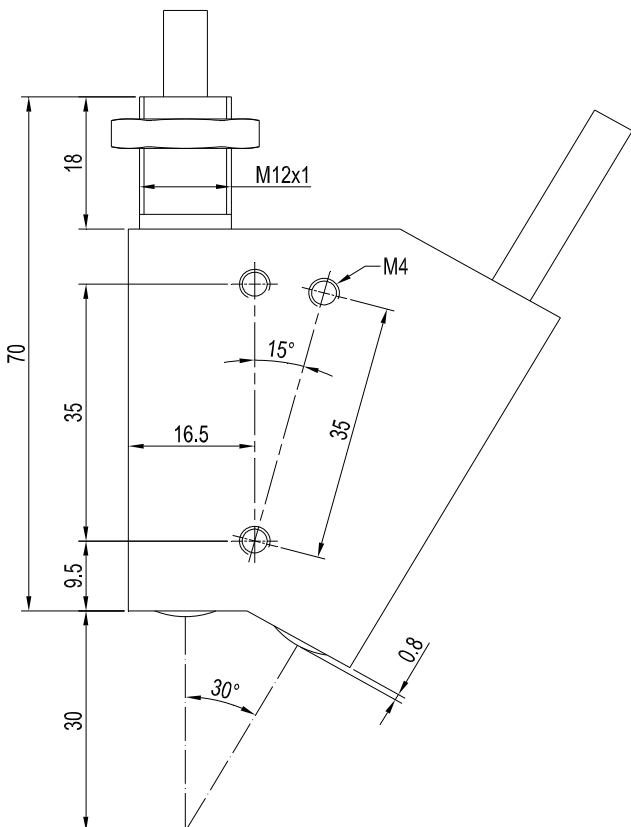
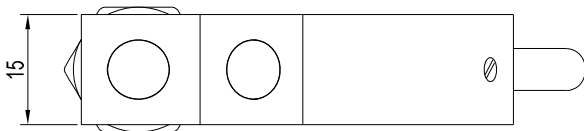

All dimensions in mm



KL-M12-XL-A2.0

**KL-M12-XL-A2.0 (focused to 25 mm)
+ R-S-A2.0-(2.5)-1200-67°
Spot Ø [mm]**

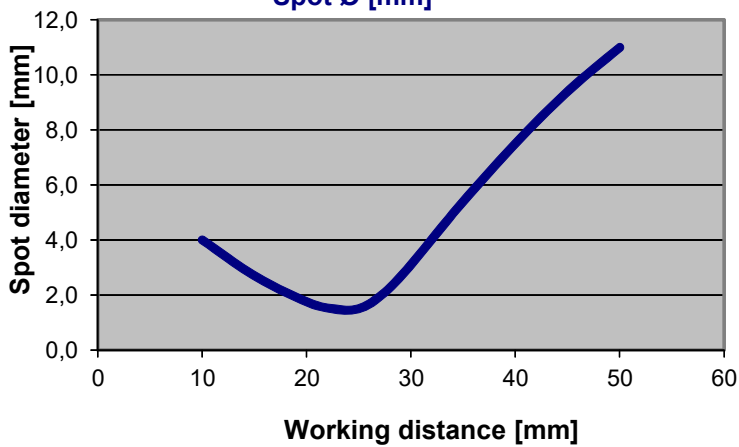

**KL-M12-XL-A2.0 with R-S-A2.0-(2.5)-1200-67°:
(focused to a distance of 25 mm):**

Spot diameter:
4 mm (typ.) at working distance 10 mm
2 mm (typ.) at working distance 20 mm
11 mm (typ.) at working distance 50 mm

**KL-M12-XL-A2.0 (focused to 50 mm)
+ R-S-A2.0-(2.5)-1200-67°
Spot Ø [mm]**

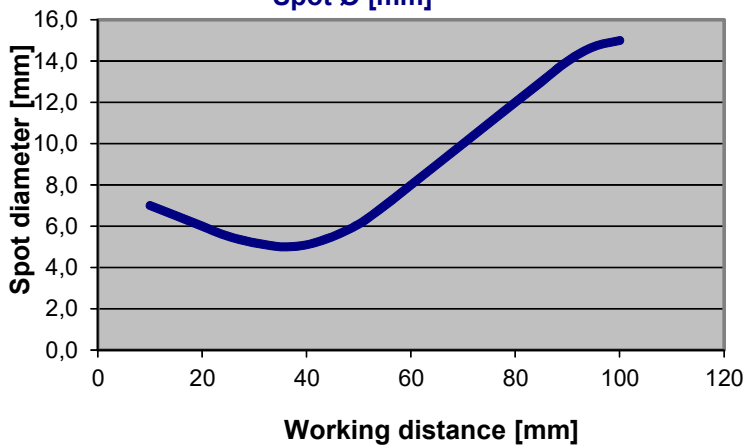

**KL-M12-XL-A2.0 with R-S-A2.0-(2.5)-1200-67°:
(focused to a distance of 50 mm):**

Spot diameter:
7 mm (typ.) at working distance 10 mm
5 mm (typ.) at working distance 40 mm
14 mm (typ.) at working distance 90 mm



KL-M12-XL-A2.0

**KL-M12-XL-A2.0 (focused to 25 mm)
+ R-S-A2.0-(2.5)-1200-67°
INT [relative]**

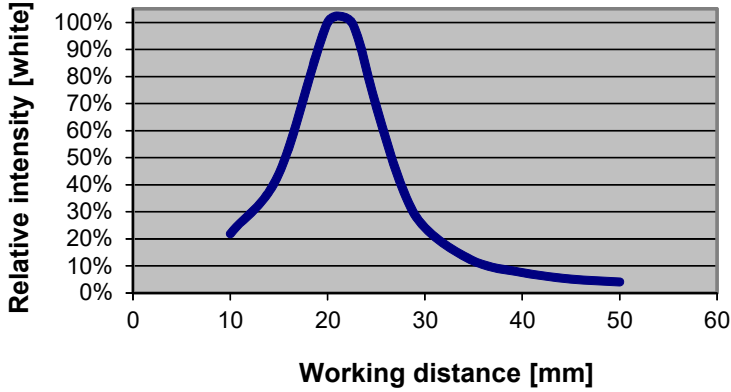

**KL-M12-XL-A2.0 with R-S-A2.0-(2.5)-1200-67°:
(focused to a distance of 25 mm):**

Relative intensity:
100% at working distance 20 mm
(INTENSITY 3317)

**KL-M12-XL-A2.0 (focused to 50 mm)
+ R-S-A2.0-(2.5)-1200-67°
INT [relative]**

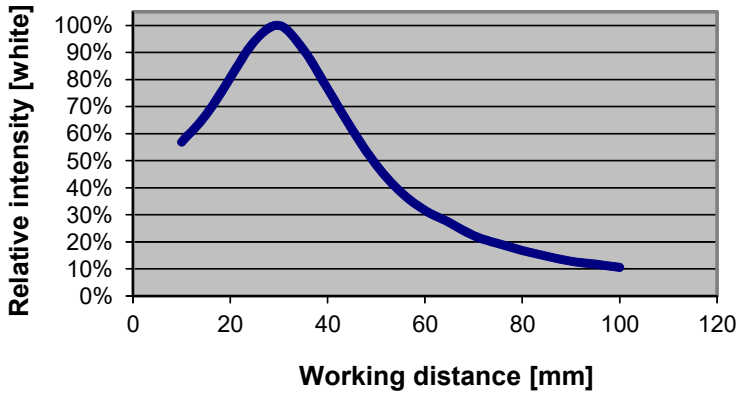

**KL-M12-XL-A2.0 with R-S-A2.0-(2.5)-1200-67°:
(focused to a distance of 50 mm):**

Relative intensity:
100% at working distance 30 mm
(INTENSITY 3410)



KL-M18-...

Reflection optics
KL-M18-A1.1

Suitable for fiber optics
R-S-A1.1-(0.6)-(length)-67° or
R-S-A1.1-(1.0)-(length)-67° or
R-S-A1.1-(1.5)-(length)-67°
R-S-A2.0-(2.5)-(length)-67°
R-S-A3.0-(3.0)-(length)-67°
T-S-M5.0-(5.0)-(length)-67°
T-S-M6.0-(6.0)-(length)-67°
T-S-M8.0-(8.0)-(length)-67°
R-S-R1.1-(3x0.5)-(length)-67°
R-S-R2.1-(6x1)-(length)-67°

KL-M18-A2.0
KL-M18-A3.0
KL-M18-M5.0
KL-M18-M6.0
KL-M18-M8.0
KL-M18-R1.1
KL-M18-R2.1



Characteristics:

- Suitable also for detection of highly absorbing objects (e.g. black varnished parts)
- Working distance typ. 20 mm ... 60 mm
- Minimal color change when changing the distance
- Can be focused
- Scratch-resistant optics made of glass
- Sturdy aluminium housing, anodized in black

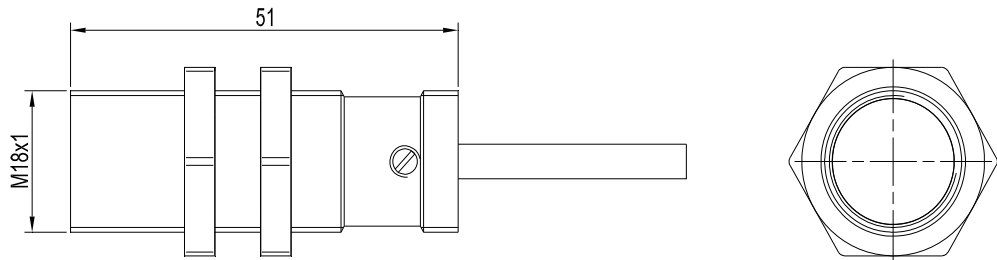

All dimensions in mm

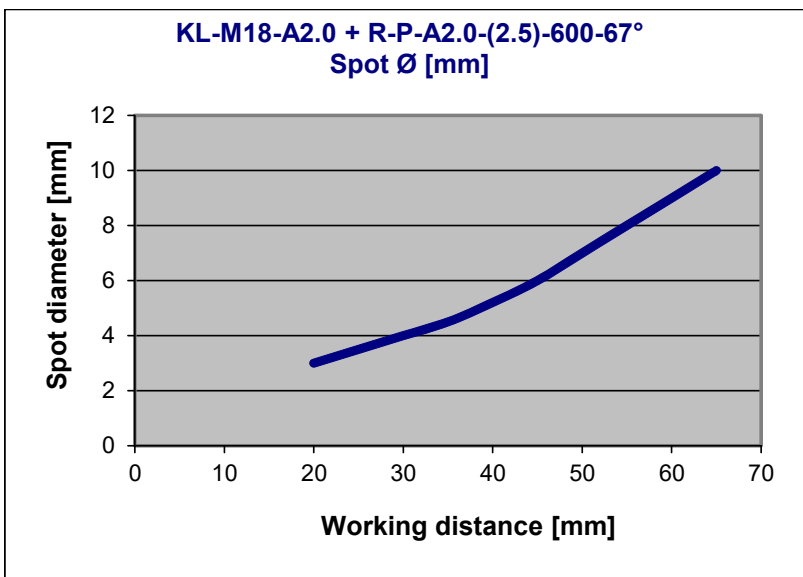

KL-M18 with R-P-A2.0-(2.5)-600-67°:

Spot diameter:
3 mm (typ.) at working distance 20 mm
5 mm (typ.) at working distance 50 mm
10 mm (typ.) at working distance 60 mm



KL-M18-XL-...

**Reflection optics
KL-M18-XL-A1.1**

Suitable for fiber optics
 R-S-A1.1-(0.6)-(length)-67° or
 R-S-A1.1-(1.0)-(length)-67° or
 R-S-A1.1-(1.5)-(length)-67°
 R-S-A2.0-(2.5)-(length)-67°
 R-S-A3.0-(3.0)-(length)-67°
 R-S-M5.0-(5.0)-(length)-67°
 R-S-M6.0-(6.0)-(length)-67°
 R-S-M8.0-(8.0)-(length)-67°
 R-S-R1.1-(3x0.5)-(length)-67°
 R-S-R2.1-(6x1)-(length)-67°

- KL-M18-XL-A2.0
- KL-M18-XL-A3.0
- KL-M18-XL-M5.0
- KL-M18-XL-M6.0
- KL-M18-XL-M8.0
- KL-M18-XL-R1.1
- KL-M18-XL-R2.1



Characteristics:

- Suitable also for detection of highly absorbing objects (e.g. black varnished parts)
- Working distance typ. 10 mm ... 200 mm
- Minimal color change when changing the distance
- Can be focused
- Scratch-resistant optics made of glass
- Sturdy aluminum housing, anodized in black

All dimensions in mm

KL-M18-XL-A1.1
 KL-M18-XL-A2.0
 KL-M18-XL-A3.0

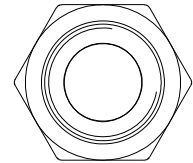
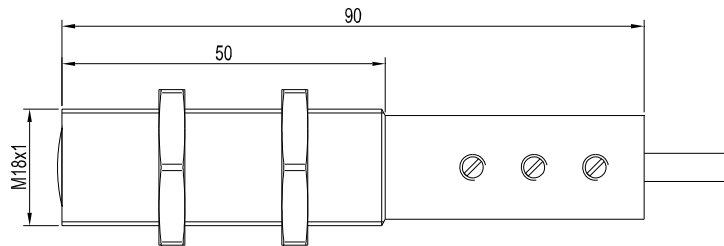

KL-M18-XL-R1.1
 KL-M18-XL-R2.1

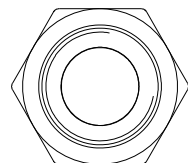
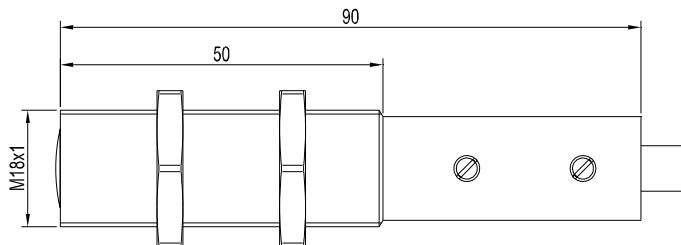

KL-M18-XL-M5.0
 KL-M18-XL-M6.0

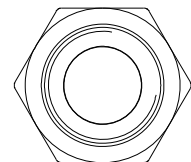
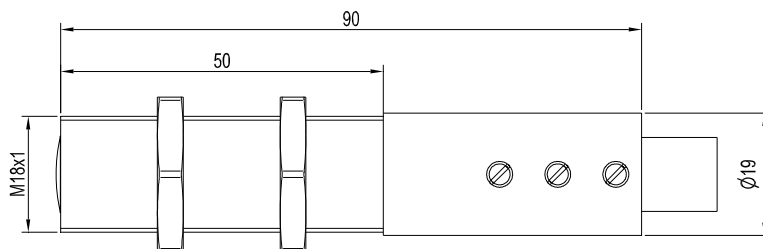

KL-M18-XL-M8.0

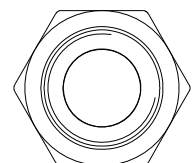
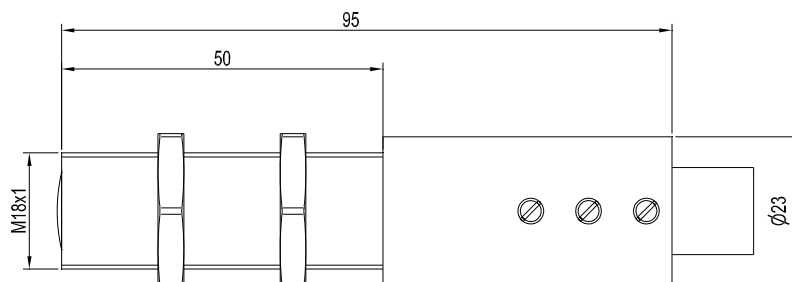



KL-M18-XL-A2.0

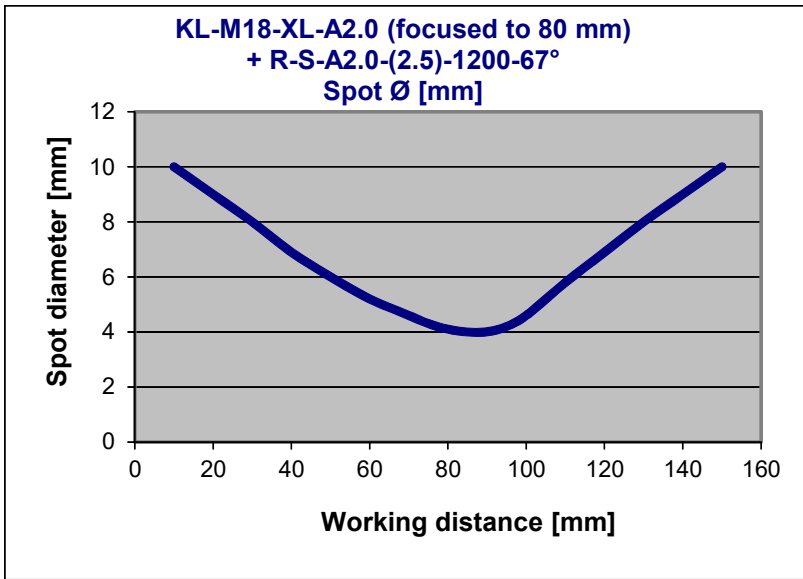

**KL-M18-XL-A2.0 with R-S-A2.0-(2.5)-1200-67°:
(focused to a distance of 80 mm):**

Spot diameter:
 10 mm (typ.) at working distance 10 mm
 4 mm (typ.) at working distance 90 mm
 9 mm (typ.) at working distance 140 mm

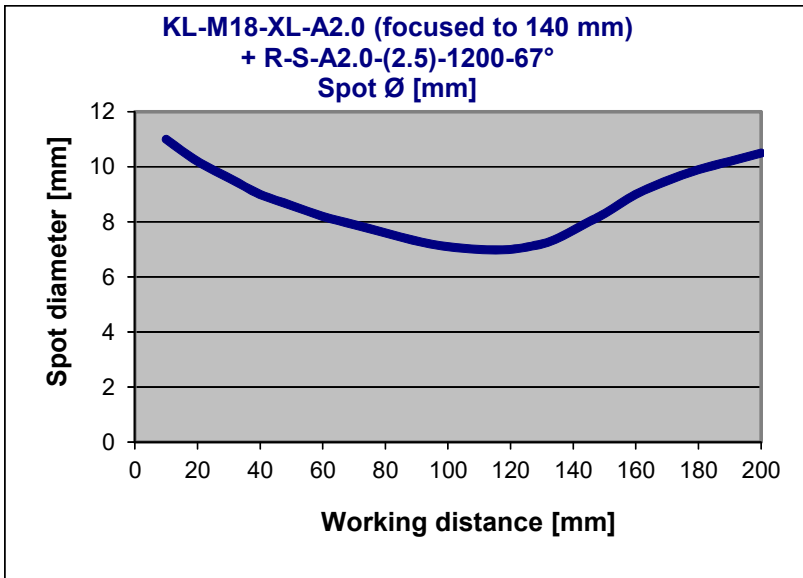

**KL-M18-XL-A2.0 with R-S-A2.0-(2.5)-1200-67°:
(focused to a distance of 140 mm):**

Spot diameter:
 11 mm (typ.) at working distance 10 mm
 7 mm (typ.) at working distance 120 mm
 10 mm (typ.) at working distance 180 mm

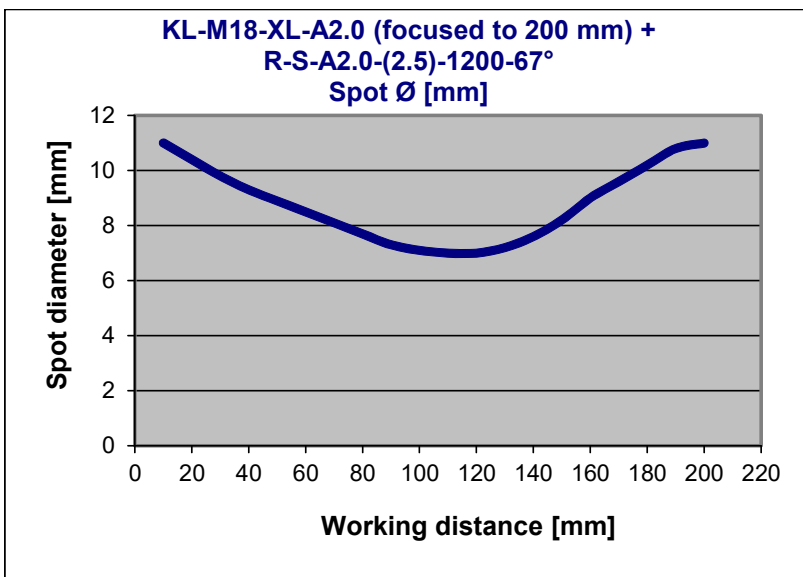

**KL-M18-XL-A2.0 with R-S-A2.0-(2.5)-1200-67°:
(focused to a distance of 200 mm):**

Spot diameter:
 11 mm (typ.) at working distance 10 mm
 7 mm (typ.) at working distance 120 mm
 11 mm (typ.) at working distance 200 mm





KL-M18-XL-A2.0

**KL-M18-XL-A2.0 (focused to 80 mm)
+ R-S-A2.0-(2.5)-1200-67°
INT [relative]**

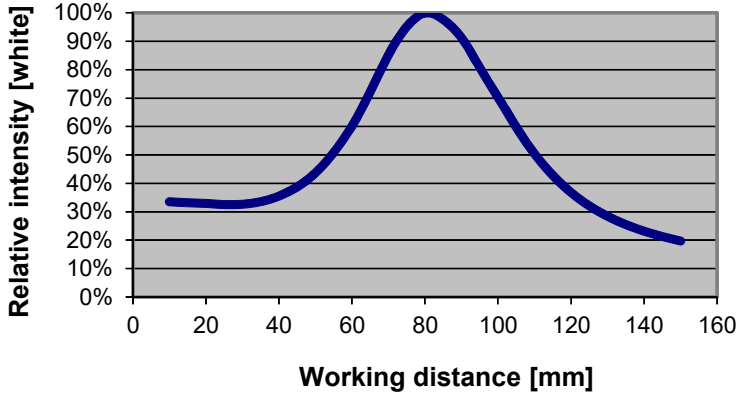

**KL-M18-XL-A2.0 with R-S-A2.0-(2.5)-1200-67°:
(focused to a distance of 80 mm):**

Relative intensity:
100% at working distance 80 mm
(INTENSITY 3615)

**KL-M18-XL-A2.0 (focused to 140 mm)
+ R-S-A2.0-(2.5)-1200-67°
INT [relative]**

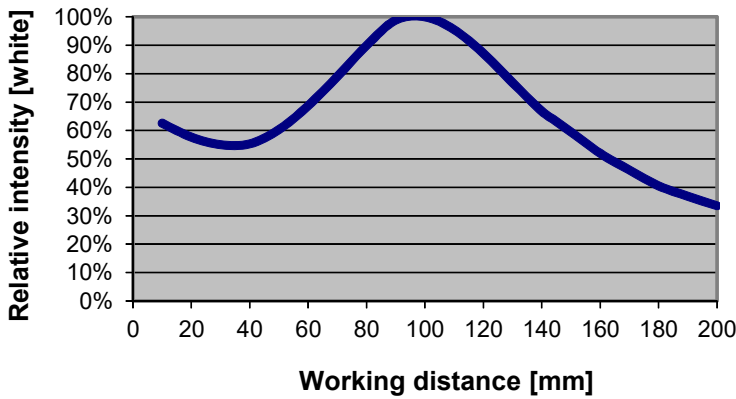

**KL-M18-XL-A2.0 with R-S-A2.0-(2.5)-1200-67°:
(focused to a distance of 140 mm):**

Relative intensity:
100% at working distance 100 mm
(INTENSITY 3580)

**KL-M18-XL-A2.0 (focused to 200 mm)
+ R-S-A2.0-(2.5)-1200-67°
INT [relative]**

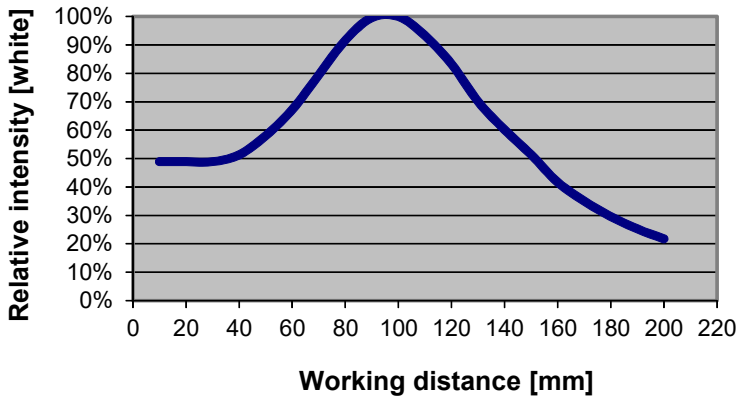

**KL-M18-XL-A2.0 with R-S-A2.0-(2.5)-1200-67°:
(focused to a distance of 200 mm):**

Relative intensity:
100% at working distance 100 mm
(INTENSITY 1636)





KL-M34-...

Reflection optics
KL-M34-A1.1

Suitable for fiber optics
R-S-A1.1-(0.6)-(length)-67° or
R-S-A1.1-(1.0)-(length)-67° or
R-S-A1.1-(1.5)-(length)-67°
R-S-A2.0-(2.5)-(length)-67°
R-S-A3.0-(3.0)-(length)-67°
T-S-M5.0-(5.0)-(length)-67°
T-S-M6.0-(6.0)-(length)-67°
T-S-M8.0-(8.0)-(length)-67°
R-S-R1.1-(3x0.5)-(length)-67°
R-S-R2.1-(6x1)-(length)-67°

KL-M34-A2.0
KL-M34-A3.0
KL-M34-M5.0
KL-M34-M6.0
KL-M34-M8.0
KL-M34-R1.1
KL-M34-R2.1



Characteristics:

- Suitable also for detection of highly absorbing objects (e.g. black varnished parts)
- Working distance typ. 100 mm ... 250 mm
- Minimal color change when changing the distance
- Can be focused
- Scratch-resistant optics made of glass
- Sturdy aluminum housing, anodized in black

All dimensions in mm

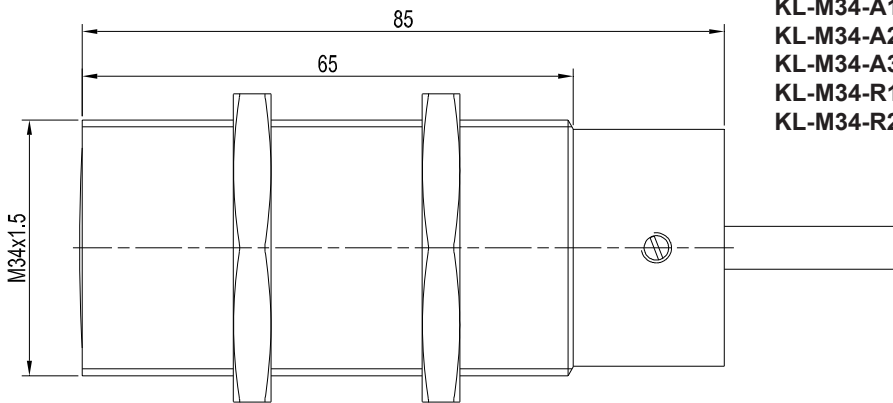

KL-M34-A1.1
KL-M34-A2.0
KL-M34-A3.0
KL-M34-R1.1
KL-M34-R2.1

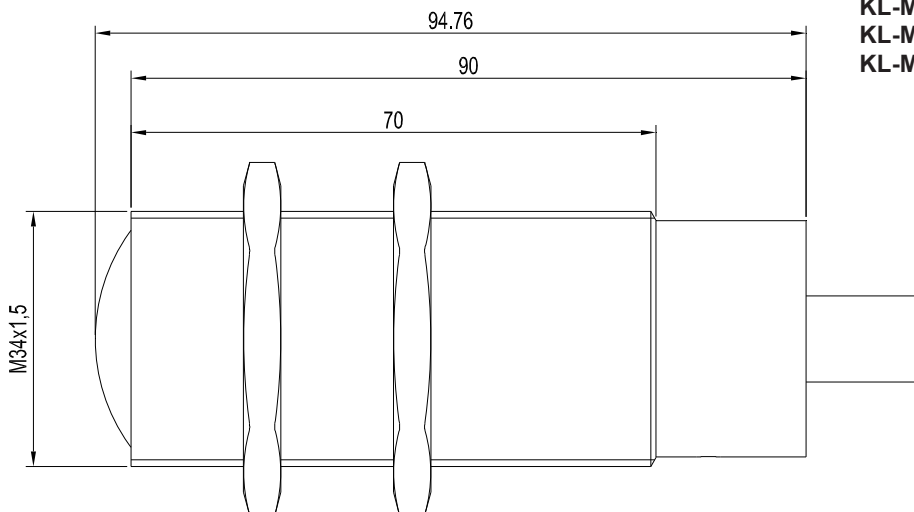
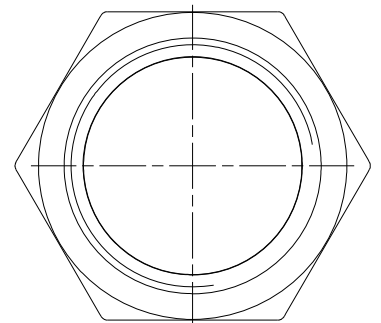

KL-M34-M5.0
KL-M34-M6.0
KL-M34-M8.0

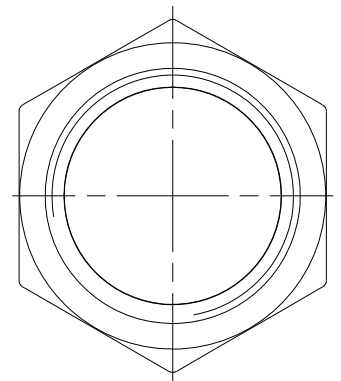



KL-M34-A2.0

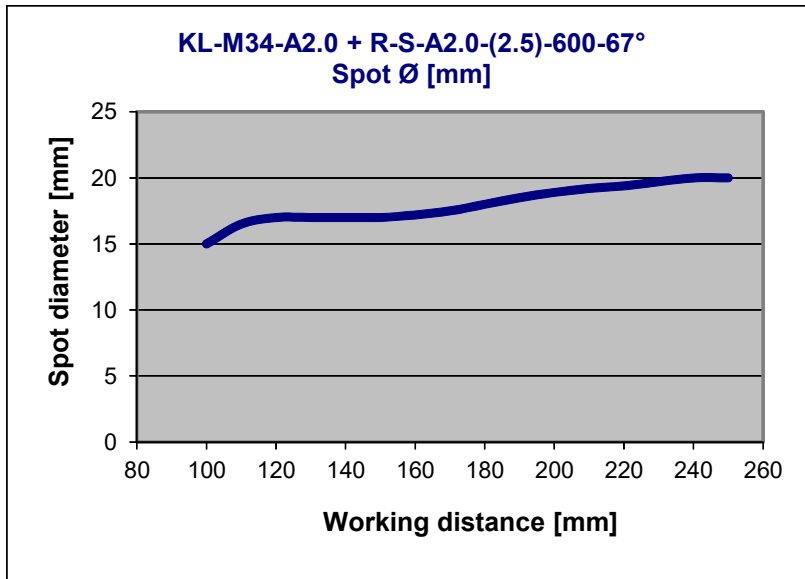

KL-M34-A2.0 with R-S-A2.0-(2.0)-600-67°:

Spot diameter:

- 15 mm (typ.) at working distance 100 mm
- 18 mm (typ.) at working distance 180 mm
- 20 mm (typ.) at working distance 250 mm

At a distance from 100 to 150 mm, intensity can be increased by means of readjusting the focus (slightly pull out optical fiber towards the back of the KL-M34).



KL-M34-XL-...

**Reflection optics
KL-M34-XL-A1.1**

Suitable for fiber optics
 R-S-A1.1-(0.6)-(length)-67° or
 R-S-A1.1-(1.0)-(length)-67° or
 R-S-A1.1-(1.5)-(length)-67°
 R-S-A2.0-(2.5)-(length)-67°
 R-S-A3.0-(3.0)-(length)-67°
 T-S-M5.0-(5.0)-(length)-67°
 T-S-M6.0-(6.0)-(length)-67°
 T-S-M8.0-(8.0)-(length)-67°
 R-S-R1.1-(3x0.5)-(length)-67°
 R-S-R2.1-(6x1)-(length)-67°

- KL-M34-XL-A2.0**
- KL-M34-XL-A3.0**
- KL-M34-XL-M5.0**
- KL-M34-XL-M6.0**
- KL-M34-XL-M8.0**
- KL-M34-XL-R1.1**
- KL-M34-XL-R2.1**



Characteristics:

- Suitable also for detection of highly absorbing objects (e.g. black varnished parts)
- Working distance typ. 50 mm ... 400 mm
- Minimal color change when changing the distance
- Can be focused
- Scratch-resistant optics made of glass
- Sturdy aluminum housing, anodized in black

- KL-M34-XL-A1.1**
- KL-M34-XL-A2.0**
- KL-M34-XL-A3.0**
- KL-M34-XL-M5.0**
- KL-M34-XL-M6.0**

All dimensions in mm

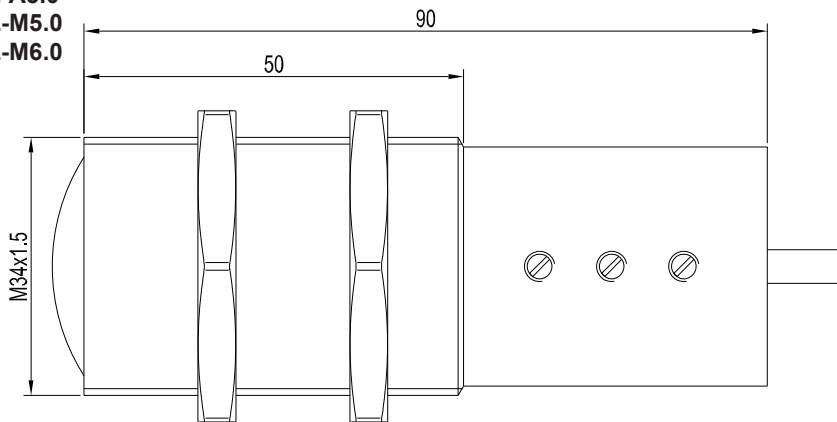

- KL-M34-XL-R1.1**
- KL-M34-XL-R2.1**

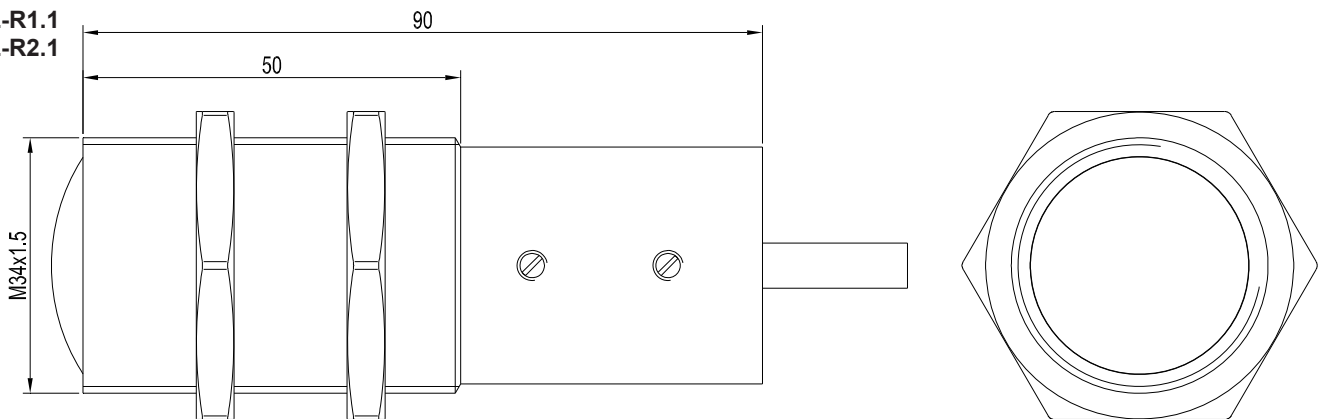



KL-M34-XL-A1.1

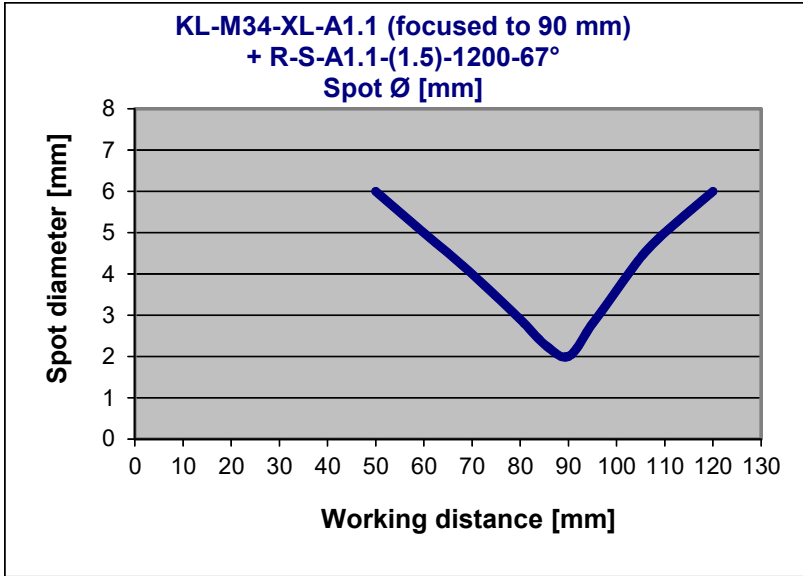

**KL-M34-XL-A1.1 with R-S-A1.1-(1.5)-1200-67°:
(focused to a distance of 90 mm):**

Spot diameter:
6 mm (typ.) at working distance 50 mm
2 mm (typ.) at working distance 90 mm
6 mm (typ.) at working distance 120 mm

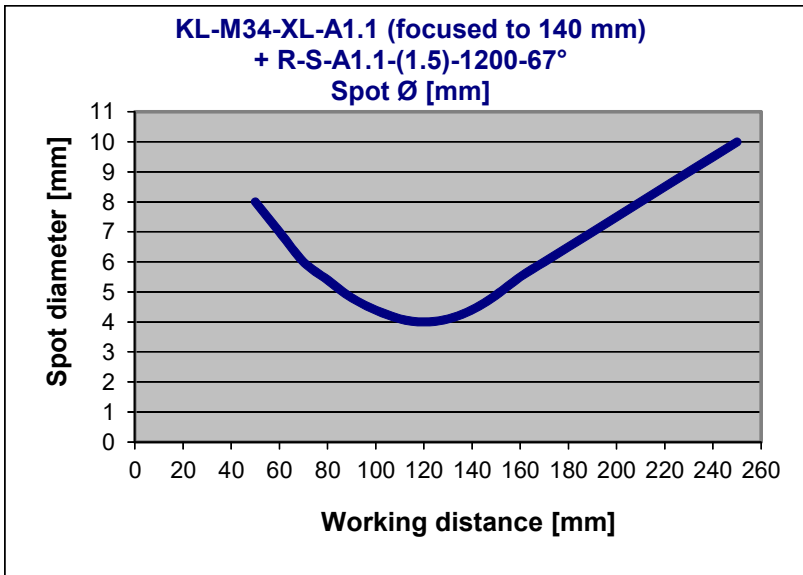

**KL-M34-XL-A1.1 with R-S-A1.1-(1.5)-1200-67°:
(focused to a distance of 140 mm):**

Spot diameter:
8 mm (typ.) at working distance 50 mm
4 mm (typ.) at working distance 130 mm
10 mm (typ.) at working distance 250 mm

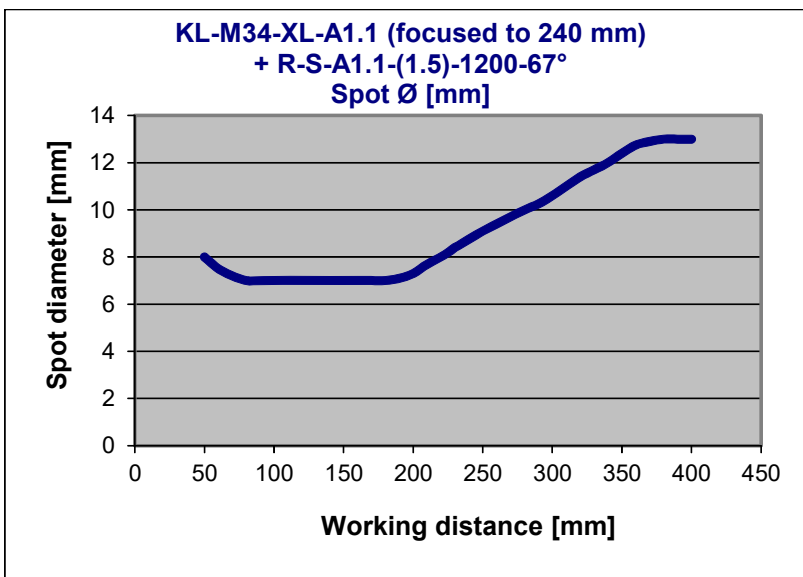

**KL-M34-XL-A1.1 with R-S-A1.1-(1.5)-1200-67°:
(focused to a distance of 240 mm):**

Spot diameter:
7 mm (typ.) at working distance 60 mm
9 mm (typ.) at working distance 250 mm
13 mm (typ.) at working distance 400 mm





KL-M34-XL-A1.1

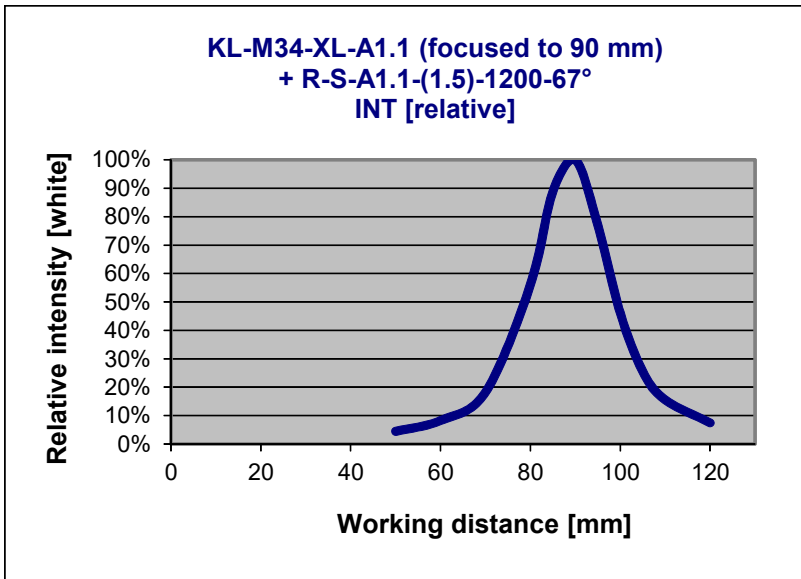

**KL-M34-XL-A1.1 with R-S-A1.1-(1.5)-1200-67°:
(focused to a distance of 90 mm):**

Relative intensity:
100% at working distance 90 mm
(INTENSITY 3918)

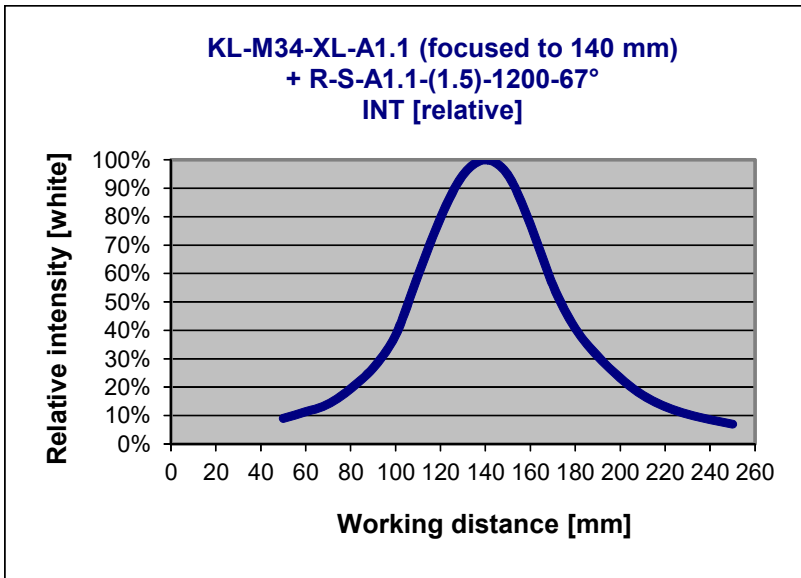

**KL-M34-XL-A1.1 with R-S-A1.1-(1.5)-1200-67°:
(focused to a distance of 140 mm):**

Relative intensity:
100% at working distance 140 mm
(INTENSITY 3850)

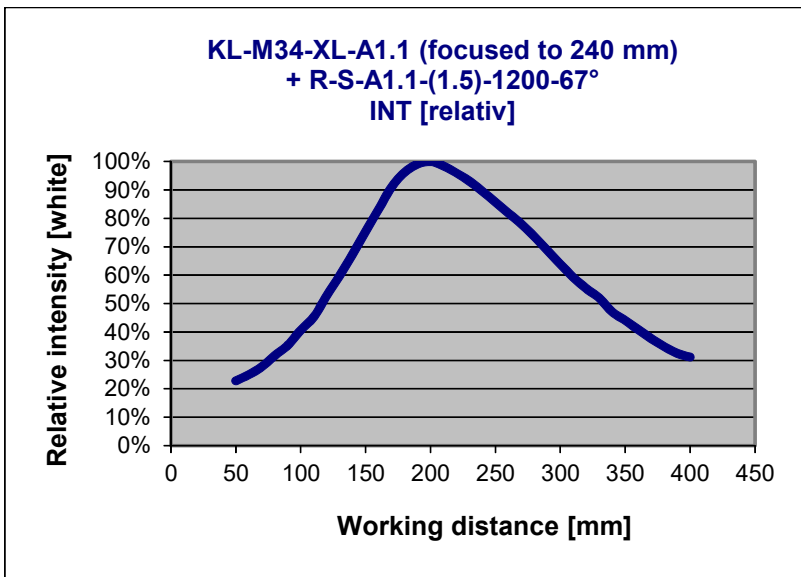

**KL-M34-XL-A1.1 with R-S-A1.1-(1.5)-1200-67°:
(focused to a distance of 240 mm):**

Relative intensity:
100% at working distance 200 mm
(INTENSITY 3910)





KL-M34-XL-A2.0

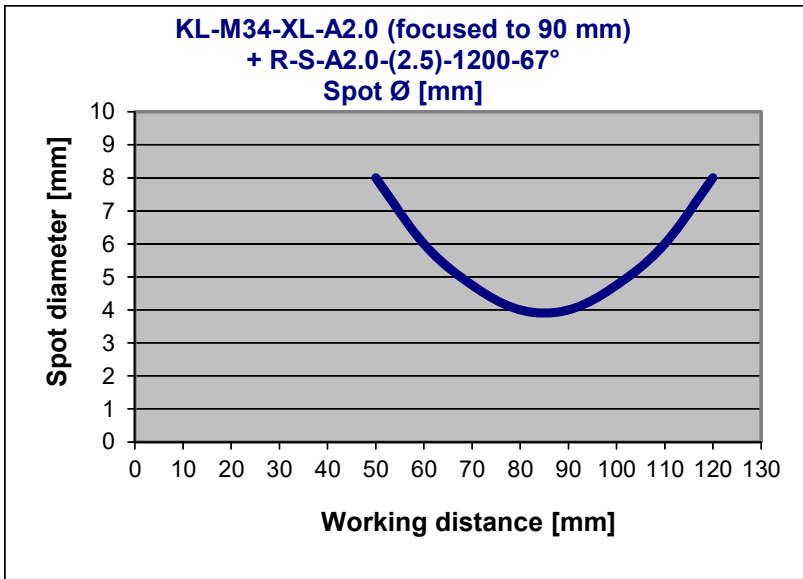

**KL-M34-XL-A2.0 with R-S-A2.0-(2.5)-1200-67°:
(focused to a distance of 90 mm):**

Spot diameter:
8 mm (typ.) at working distance 50 mm
4 mm (typ.) at working distance 85 mm
8 mm (typ.) at working distance 120 mm

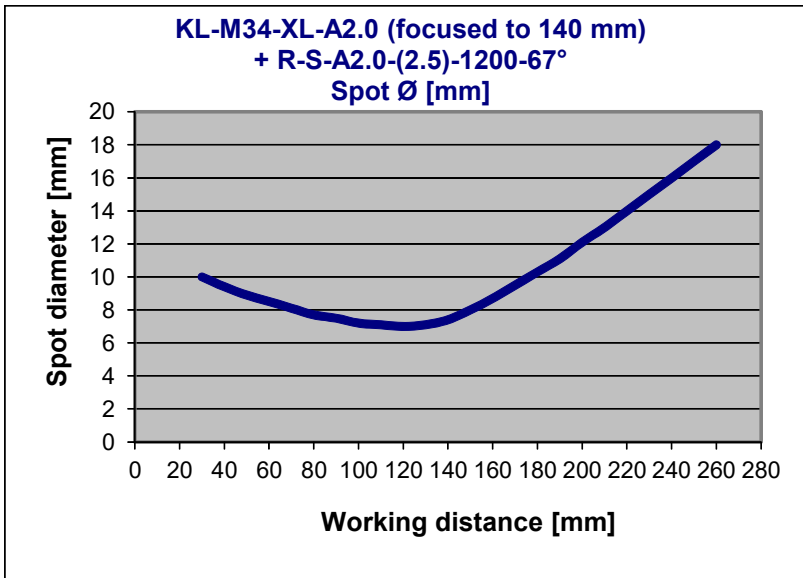

**KL-M34-XL-A2.0 with R-S-A2.0-(2.5)-1200-67°:
(focused to a distance of 140 mm):**

Spot diameter:
10 mm (typ.) at working distance 30 mm
7 mm (typ.) at working distance 130 mm
18 mm (typ.) at working distance 260 mm

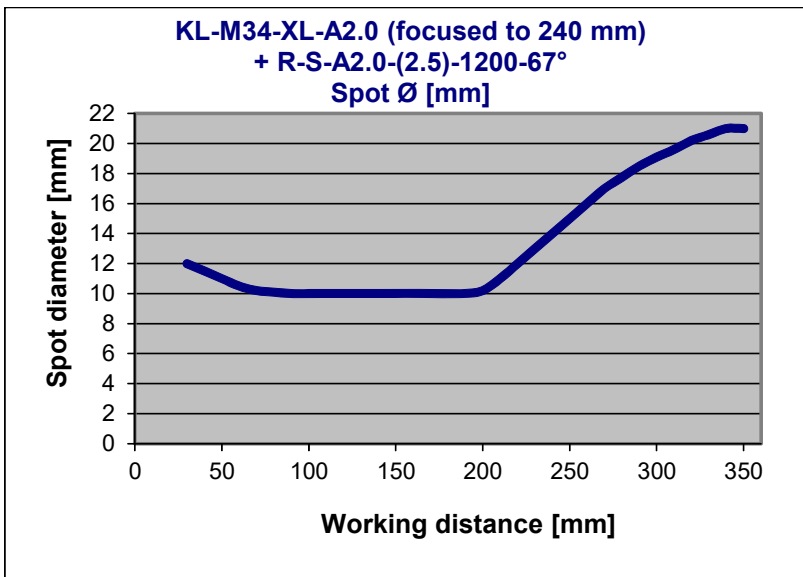

**KL-M34-XL-A2.0 with R-S-A2.0-(2.5)-1200-67°:
(focused to a distance of 240 mm):**

Spot diameter:
12 mm (typ.) at working distance 30 mm
10 mm (typ.) at working distance 150 mm
21 mm (typ.) at working distance 350 mm





KL-M34-XL-A2.0

**KL-M34-XL-A2.0 (focused to 90 mm)
+ R-S-A2.0-(2.5)-1200-67°
INT [relative]**

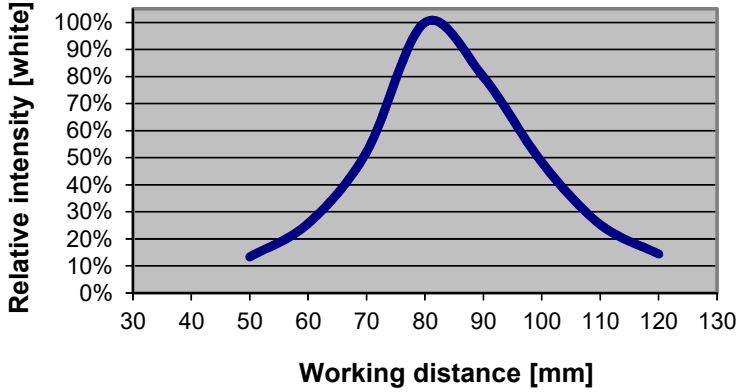

**KL-M34-XL-A2.0 with R-S-A2.0-(2.5)-1200-67°:
(focused to a distance of 90 mm):**

Relative intensity:
100% at working distance 80 mm
(INTENSITY 3596)

**KL-M34-XL-A2.0 (focused to 140 mm)
+ R-S-A2.0-(2.5)-1200-67°
INT [relative]**

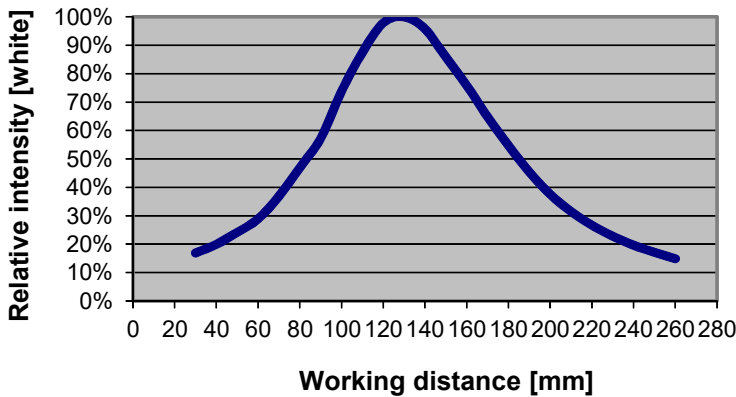

**KL-M34-XL-A2.0 with R-S-A2.0-(2.5)-1200-67°:
(focused to a distance of 140 mm):**

Relative intensity:
100% at working distance 130 mm
(INTENSITY 3728)

**KL-M34-XL-A2.0 (focused to 240 mm)
+ R-S-A2.0-(2.5)-1200-67°
INT [relative]**

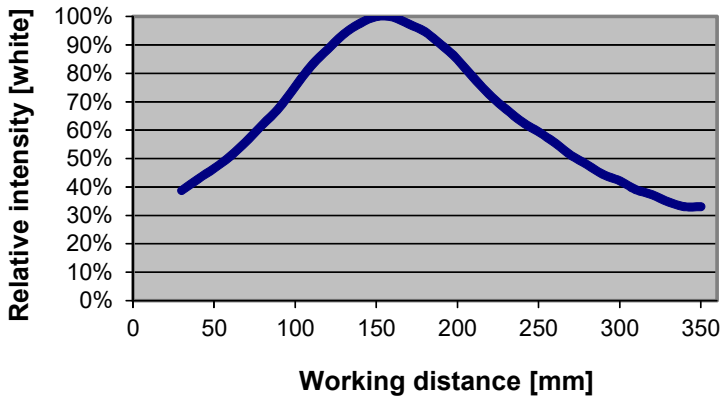

**KL-M34-XL-A2.0 with R-S-A2.0-(2.5)-1200-67°:
(focused to a distance of 240 mm):**

Relative intensity:
100% at working distance 150 mm
(INTENSITY 3518)





KL-M34-XL-A3.0

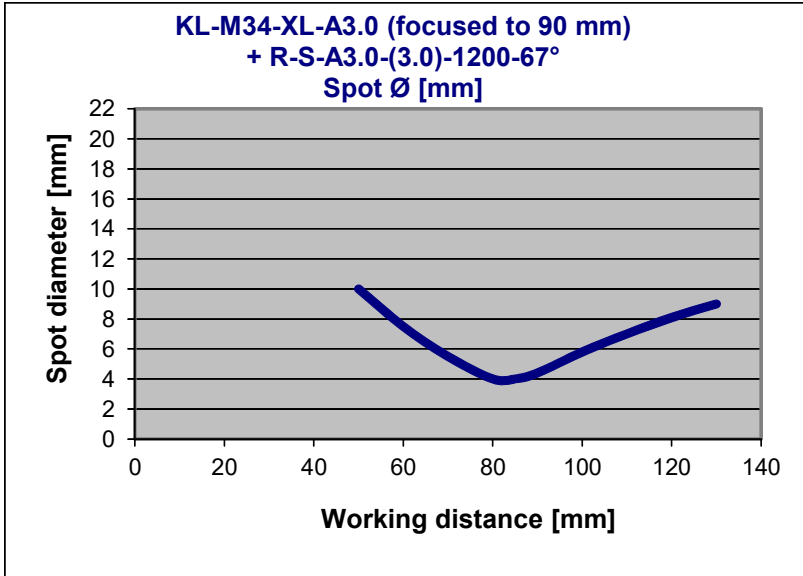

**KL-M34-XL-A3.0 with R-S-A3.0-(3.0)-1200-67°:
(focused to a distance of 90 mm):**

Spot diameter:
10 mm (typ.) at working distance 50 mm
4 mm (typ.) at working distance 80 mm
9 mm (typ.) at working distance 130 mm

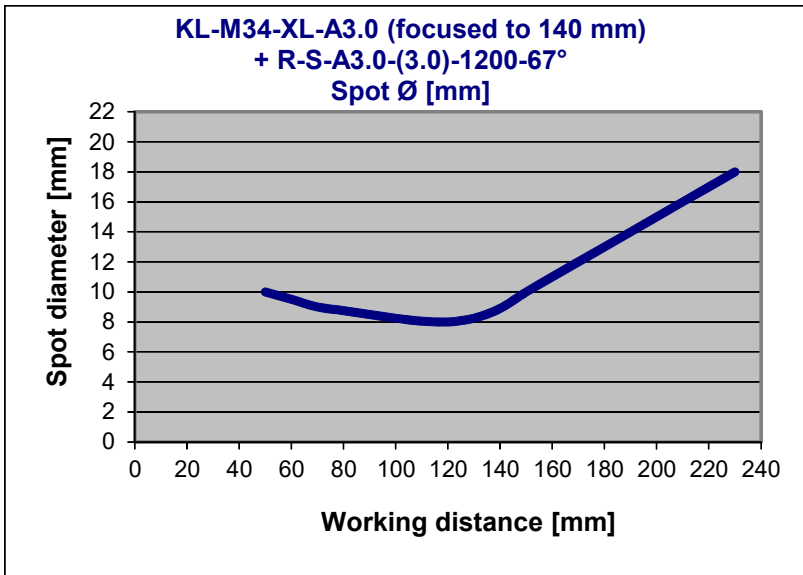

**KL-M34-XL-A3.0 with R-S-A3.0-(3.0)-1200-67°:
(focused to a distance of 140 mm):**

Spot diameter:
10 mm (typ.) at working distance 50 mm
8 mm (typ.) at working distance 130 mm
18 mm (typ.) at working distance 230 mm

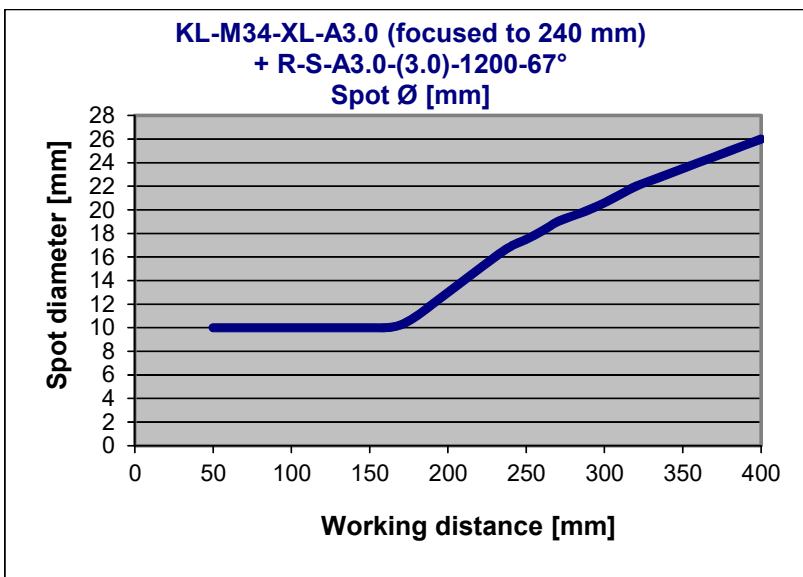

**KL-M34-XL-A3.0 with R-S-A3.0-(3.0)-1200-67°:
(focused to a distance of 240 mm):**

Spot diameter:
10 mm (typ.) at working distance 50 mm
18 mm (typ.) at working distance 260 mm
26 mm (typ.) at working distance 400 mm





KL-M34-XL-A3.0

**KL-M34-XL-A3.0 (focused to 90 mm)
+ R-S-A3.0-(3.0)-1200-67°
INT [relative]**

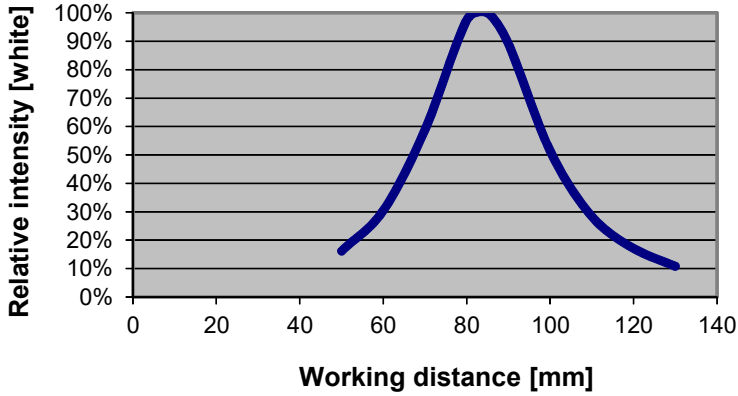

**KL-M34-XL-A3.0 with R-S-A3.0-(3.0)-1200-67°:
(focused to a distance of 90 mm):**

Relative intensity:
100% at working distance 85 mm
(INTENSITY 3775)

**KL-M34-XL-A3.0 (focused to 140 mm)
+ R-S-A3.0-(3.0)-1200-67°
INT [relative]**

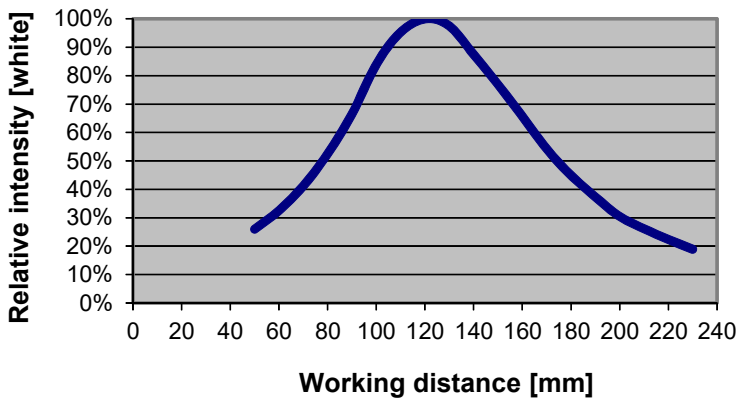

**KL-M34-XL-A3.0 with R-S-A3.0-(3.0)-1200-67°:
(focused to a distance of 140 mm):**

Relative intensity:
100% at working distance 120 mm
(INTENSITY 3658)

**KL-M34-XL-A3.0 (focused to 240 mm)
+ R-S-A3.0-(3.0)-1200-67°
INT [relative]**

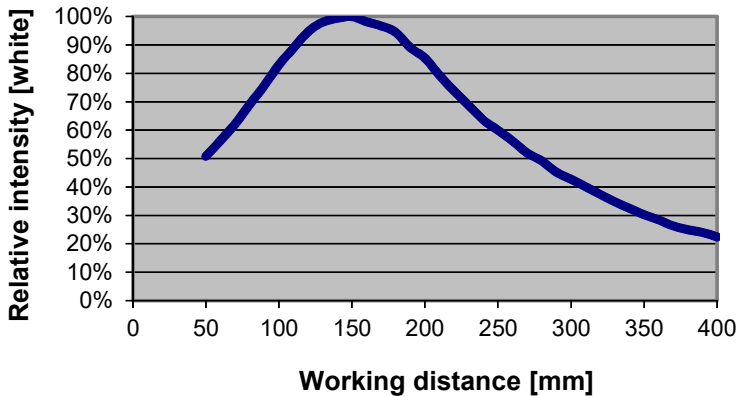

**KL-M34-XL-A3.0 with R-S-A3.0-(3.0)-1200-67°:
(focused to a distance of 240 mm):**

Relative intensity:
100% at working distance 150 mm
(INTENSITY 3855)





KL-M34/62-...

Reflective optics
KL-M34/62-A1.1

Suitable for fiber optics
 R-S-A1.1-(0.6)-(length)-67° or
 R-S-A1.1-(1.0)-(length)-67° or
 R-S-A1.1-(1.5)-(length)-67°
 R-S-A2.0-(2.5)-(length)-67°
 R-S-A3.0-(3.0)-(length)-67°
 R-S-R1.1-(3x0.5)-(length)-67°
 R-S-R2.1-(6x1)-(length)-67°

- KL-M34/62-A2.0**
- KL-M34/62-A3.0**
- KL-M34/62-R1.1**
- KL-M34/62-R2.1**

Characteristics:

- Suitable also for detection of highly absorbing objects (e.g. black varnished parts)
- Small spot (approx. 3 mm at a distance of 120 mm)
- Working distance typ. 80 mm ... 200 mm
- Minimal color change when changing the distance
- Can be focused
- Scratch-resistant optics made of glass
- Sturdy aluminum housing, anodized in black



All dimensions in mm

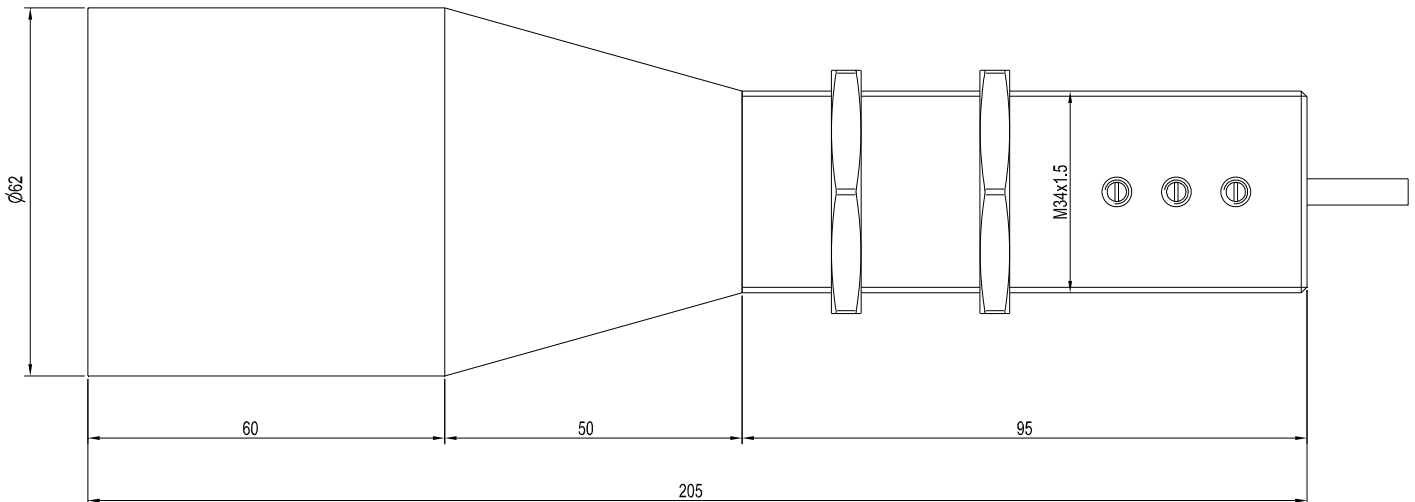



Fiber Optics Fixtures

Mounting brackets (fixtures) for transmitted light fiber optics with sensor head type „A2.0“, „A3.0“, or „R2.1“:

| Part number: | (Previous part number) | Suitable for: (D= transm. light) | Characteristics: |
|---------------------------------|------------------------|-------------------------------------|---|
| C-MOUNT-A2.0-180°-22/50 | KL-0/90°-22-A2.0 | D-S-A2.0-(2.5)-...-67° | Transmitter/receiver distance 22 mm, fork width/depth: 50/50 mm |
| C-MOUNT-A2.0-180°-60/50 | KL-0/90°-60-A2.0 | D-S-A2.0-(2.5)-...-67° | Transmitter/receiver distance 60 mm, fork width/depth: 88/50 mm |
| C-MOUNT-A2.0-180°-100/50 | KL-0/90°-100-A2.0 | D-S-A2.0-(2.5)-...-67° | Transmitter/receiver distance 100 mm, fork width/depth: 128/50 mm |
| C-MOUNT-A3.0-180°-16/50 | KL-0/90°-16-A3.0 | D-S-A3.0-(3.0)-...-67° | Transmitter/receiver distance 16 mm, fork width/depth: 50/50 mm |
| C-MOUNT-A3.0-180°-60/50 | KL-0/90°-60-A3.0 | D-S-A3.0-(3.0)-...-67° | Transmitter/receiver distance 60 mm, fork width/depth: 94/50 mm |
| C-MOUNT-A3.0-180°-100/50 | KL-0/90°-100-A3.0 | D-S-A3.0-(3.0)-...-67° | Transmitter/receiver distance 100 mm, fork width/depth: 134/50 mm |
| MOUNT-A2.0-170°-5 | KL-5/85°-A2.0 | D-S-A2.0-(2.5)-...-67° | Angle of incidence 85° to the vertical in a distance of 5 mm to the object, gloss control of extremely rough surfaces |
| MOUNT-A3.0-170°-5 | KL-5/85°-A3.0 | D-S-A3.0-(3.0)-...-67° | Angle of incidence 85° to the vertical in a distance of 5 mm to the object, gloss control of extremely rough surfaces |
| MOUNT-A2.0-150°-10 | KL-10/75°-A2.0 | D-S-A2.0-(2.5)-...-67° | Angle of incidence 75° to the vertical in a distance of 10 mm to the object, gloss control of rough surfaces |
| MOUNT-A3.0-150°-10 | KL-10/75°-A3.0 | D-S-A3.0-(3.0)-...-67° | Angle of incidence 75° to the vertical in a distance of 10 mm to the object, gloss control of rough surfaces |
| MOUNT-A2.0-120°-12 | KL-12/60°-A2.0 | D-S-A2.0-(2.5)-...-67° | Angle of incidence 60° to the vertical in a distance of 12 mm to the object, gloss control of matt to light glossy surfaces |
| MOUNT-A3.0-120°-12 | KL-12/60°-A3.0 | D-S-A3.0-(3.0)-...-67° | Angle of incidence 60° to the vertical in a distance of 12 mm to the object, gloss control of matt to light glossy surfaces |
| MOUNT-R2.1-120°-12 | KL-12/60°-R2.1 | D-S-R2.1-(6x1)-...-67° | Angle of incidence 60° to the vertical in a distance of 12 mm to the object, gloss control of matt to light glossy surfaces |
| MOUNT-A2.0-90°-15 | KL-15/45°-A2.0 | D-S-A2.0-(2.5)-...-67° | Angle of incidence 45° to the vertical in a distance of 15 mm to the object, gloss control of matt to glossy surfaces |
| MOUNT-A3.0-90°-15 | KL-15/45°-A3.0 | D-S-A3.0-(3.0)-...-67° | Angle of incidence 45° to the vertical in a distance of 15 mm to the object, gloss control of matt to glossy surfaces |
| MOUNT-A2.0-40°-20 | KL-20/20°-A2.0 | D-S-A2.0-(2.5)-...-67° | Angle of incidence 20° to the vertical in a distance of 20 mm to the object, gloss control of very glossy surfaces |
| MOUNT-A3.0-40°-20 | KL-20/20°-A3.0 | D-S-A3.0-(3.0)-...-67° | Angle of incidence 20° to the vertical in a distance of 20 mm to the object, gloss control of very glossy surfaces |

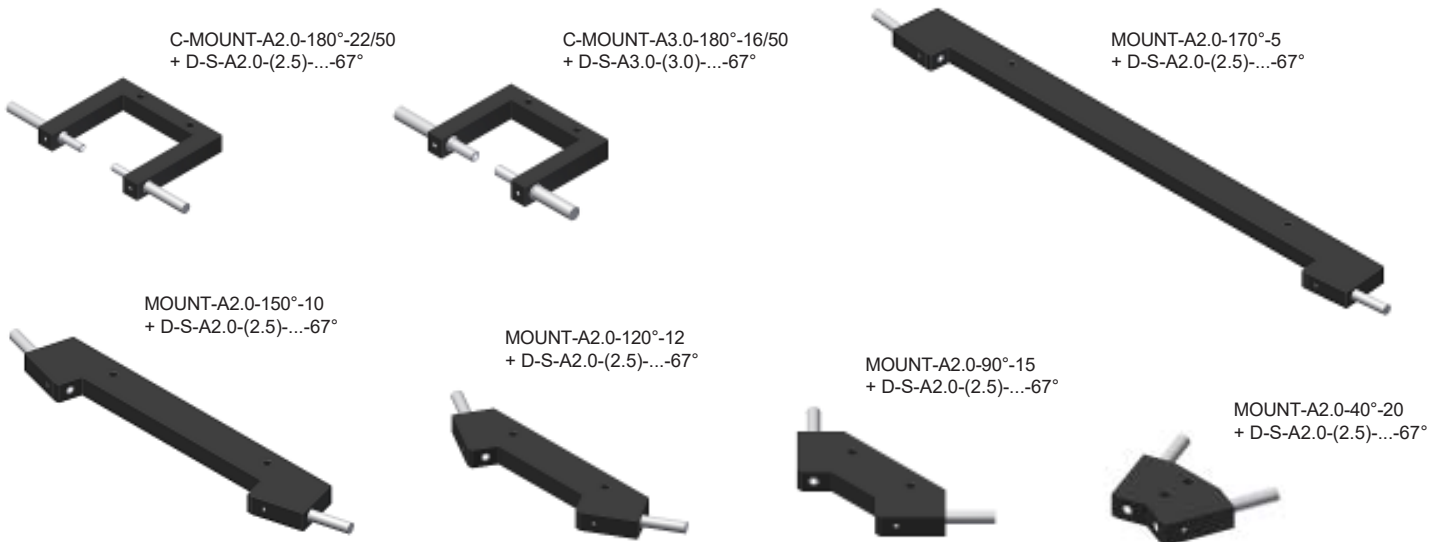



Fiber Optics Fixtures

Mounting brackets (fixtures) for transmitted light fiber optics with sensor head type „Q...“ (cross-section converter):

| Part number: | (Previous part number) | Suitable for: (D= transm. light) | Characteristics: |
|------------------------------|------------------------|-------------------------------------|--|
| C-MOUNT-Q1-180°-50/50 | KL-50/50-5 | D-S-Q1-(5x0.5)-...-67° | Width of measuring range: 5 mm, transmitter/receiver distance: 50 mm, distance beginning of measurement range (inner side) to inner edge of housing: 50 mm |
| C-MOUNT-Q2-180°-50/50 | KL-50/50-10 | D-S-Q2-(10x0.3)-...-67° | Width of measuring range: 10 mm, transmitter/receiver distance: 50 mm, distance beginning of measurement range (inner side) to inner edge of housing: 50 mm |
| C-MOUNT-Q3-180°-50/50 | KL-50/50-18 | D-S-Q3-(18x0.3)-...-67° | Width of measuring range: 18 mm, transmitter/receiver distance: 50 mm, distance beginning of measurement range (inner side) to inner edge of housing: 50 mm |
| C-MOUNT-Q4-180°-50/50 | KL-50/50-28 | D-S-Q4-(28x0.2)-...-67° | Width of measuring range: 28 mm, transmitter/receiver distance: 50 mm, Adistance beginning of measurement range (inner side) to inner edge of housing: 50 mm |
| C-MOUNT-Q5-180°-50/50 | KL-50/50-38 | D-S-Q5-(38x0.15)-...-67° | Width of measuring range: 38 mm, transmitter/receiver distance: 50 mm, distance beginning of measurement range (inner side) to inner edge of housing: 50 mm |
| C-MOUNT-Q6-180°-50/50 | KL-50/50-48 | D-S-Q6-(48x0.15)-...-67° | Width of measuring range: 48 mm, transmitter/receiver distance: 50 mm, distance beginning of measurement range (inner side) to inner edge of housing: 50 mm |



C-MOUNT-Q1-180°-50/50
+ D-S-Q1-(5x0.5)-...-67°

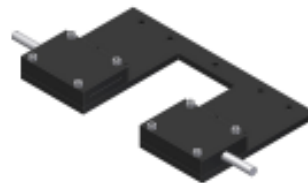

C-MOUNT-Q4-180°-50/50
+ D-S-Q4-(28x0.2)-...-67°



C-MOUNT-Q2-180°-50/50
+ D-S-Q2-(10x0.3)-...-67°

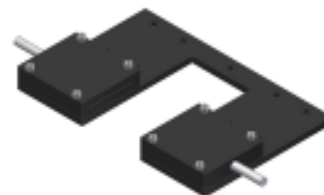

C-MOUNT-Q5-180°-50/50
+ D-S-Q5-(38x0.15)-...-67°



C-MOUNT-Q3-180°-50/50
+ D-S-Q3-(18x0.3)-...-67°

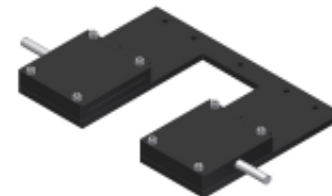

C-MOUNT-Q6-180°-50/50
+ D-S-Q6-(48x0.15)-...-67°

Accessories

| Part number: | Suitable for fiber optics type: (R = reflected light) | Characteristics: |
|--------------|--|------------------|
|--------------|--|------------------|

Neutral glass filter top-parts for fiber optics:

| | |
|-------------------|------------------|
| KL-M12-A2.0-NG4 | R-P-A2.0-... |
| KL-M12-A2.0-NG5 | R-P-A2.0-... |
| KL-M12-A2.0-NG9 | R-P-A2.0-... |
| KL-M12-A2.0-NG9x2 | R-P-A2.0-... |
| KL-M12-A2.0-NG11 | R-P-A2.0-... |
| KL-M12-AP1.0-NG4 | R-P-AP1.0-...-Ms |
| KL-M12-AP1.0-NG5 | R-P-AP1.0-...-Ms |
| KL-M12-AP1.0-NG9 | R-P-AP1.0-...-Ms |
| KL-M12-AP1.0-NG11 | R-P-AP1.0-...-Ms |

Offline top-parts (spacer) for fiber optics:

| | |
|--------------------|--------------|
| A2.0-OFL | R-S-A2.0-... |
| A2.0-OFL-SHIFT | R-S-A2.0-... |
| A3.0-OFL | R-S-A3.0-... |
| A3.0-OFL-10 | R-S-A3.0-... |
| A3.0-OFL-D14/6 | R-S-A3.0-... |
| A3.0-OFL-D17-SHIFT | R-S-A3.0-... |
| A3.0-OFL-SHIFT | R-S-A3.0-... |

Adjustment top-part for optical frontend:

| | |
|-----------------|---|
| KL-M18-A2.0-ADJ | suitable for optical frontend KL-M18-A2.0 |
|-----------------|---|